

JEANTER  
键特

定制  
CUSTOMIZED



### 广州键特办公家具有限公司

Guangzhou Jeanter Steel Office Furniture Co.,Ltd

工厂地址: 广州市南沙区榄核镇星海路2-3号

电话: 4008720988

邮箱: gzjeanter@163.com

国内网站: www.jjtgy.com

国际网站: www.jeanter-cabinet.com

Factory Add: 101, No 2-3 Xinghai Road, Lanhe Town,  
Nansha District, Guangzhou City, Guangdong Province, China

Tel: 4008720988

E-Mail: gzjeanter@163.com

Domestic Web: http://www.jjtgy.com

International Web: www.jeanter-cabinet.com

由于印刷关系, 可能与实际产品的颜色有差异, 使用时请以实物颜色为准



CONCERNED  
ABOUT  
ENVIRON  
MENTAL  
PROTECTION

CARING FOR THE EARTH ADHERE TO  
SUSTAINABLE DEVELOPMENT  
关注环保，关爱地球  
坚持可持续发展

公司介绍	1-2
智能柜	3-10
矮柜	13-16
高柜	17-22
活动柜	23-24
卷门柜	25-26
横抽柜	27-28
卡箱柜	35-36
图纸柜	29-30
衣柜储物柜	31-34
书架	35-36
密集架	37-39
货架	40-44
公寓床	45-46
工艺和品质	47-50



# DESIGN FOR LIFE



广州键特办公家具有限公司座落于风景优美的著名音乐家冼星海故居---南沙区榄核镇，独立式花园工厂，占地2万多方，是集研发，销售定制生产于一体的高档钣金家具设备企业。企业以雄厚的技术力量，先进的生产流水线和生产工艺，以及一支高素质的科研、管理队伍，为企业的进一步发展提供了坚实的保障。

本公司专业定制生产高端钢制办公柜、出口拆装柜、智能物联网柜、不锈钢储物柜及来图定制高端柜类钣金家具设备；已形成了八大系列和180多种产品的生产规模和新产品开发能力。公司已建立完善的质量管理体系认证、环境管理体系认证、国际权威资质认证机构的认证。先后推出“金键特行业”时尚办公品牌和“键特科技”智慧办公品牌服务遍及全国各个省、市、自治区的国家机关、社会团体、大专院校及大型工商企业；并远销欧美、中东、非洲等几十个国家与地区。

公司始终坚持“开拓创新，价值服务”的企业精神真诚服务客户！

Guangzhou Jeanter Office Furniture Co., Ltd. is located in the Lanhe Town of Nansha District, where is the famous musician Mr Xinghai Xian's beautiful hometown. Factory site is an independent garden design, covering an area of over 20,000㎡. We are a high-end sheet metal furniture equipment company of researching, sales and customized production.

Our product series include high-end steel office cabinets, disassembled cabinets for exporting, intelligent Internet cabinets, stainless steel storage cabinets and customized high-end sheet metal furniture equipment, in total 8 series and over 180 kinds of products. We own strong technical force, advanced production lines and production technology, as well as a high-quality scientific research and management team, which providing a solid guarantee for our further development. We are qualified with a complete quality management system certification, environmental management system certification, and international authority certification. We own famous fashion office brand: "Jeaenter" and smart office brand: "Jeaenter Technology". Our products and service have been very popular throughout both domestic and foreign markets, including social organizations, colleges and universities, large industrial and commercial enterprises. we have exported to various of countries and regions including Europe, United States, Asia, Middle East, Africa etc.

We'll serve every customer sincerely by adhering to the enterprise's spirit: "exploitation and innovation, value service" all the time.



# INTELLIGENT CABINET SERIES- Smart Sharing Bed

## 智能柜系列-智能陪护床



### PRODUCT FEATURES

### 产品特点

#### 微信小程序租用陪护床流程:



第一步: 打开微信扫一扫, 扫描陪护床二维码



第二步: 点击“允许”获取你的名字、头像、地区及性别等资料。



第三步: 点“支付”支付押金。



第四步: 点“扫码开锁取床”; 扫一扫陪护床二维码即进入“套餐选择”。



第五步: 选择“按小时”或者按“时间段”; 点击“开锁”即自动弹开柜门。



第六步: 自动弹开门后会提示“开锁成功”; 若提示“开锁失败”请重新扫码; 多次开锁失败请联系客服。



第七步: 点击“查看订单”可查看进行中的订单详情, 如使用时长、收费标准、下单时间、地址等。



第八步: 点击“结束订单”并支付本次租用费用。

#### 微信小程序租用陪护床其它操作流程:



查看订单: 点击小程序菜单栏的“订单”可进行“我的订单”查询各类订单详情。



退押金第一步: 点击小程序菜单栏的“我的”点击“我的押金”进入。



退押金第二步: 进入“押金”页面后可查看已交押金情况。



退押金第三步: 点击“我要退押金”后进入退押金界面。



退押金第四步: 点击“退押金”后点击“确定”后即可。

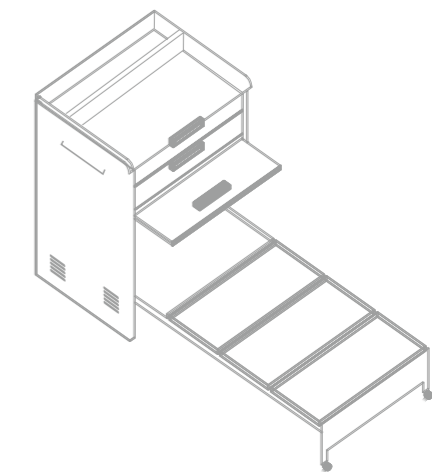
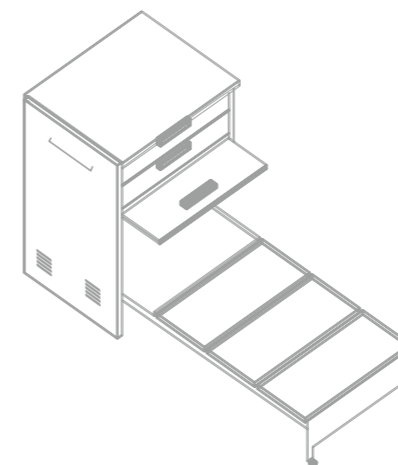



# INTELLIGENT CABINET SERIES- Intelligent Circulation Storage Box

## 智能柜系列-智能周转柜



智能周转柜，是一款基于物联网的，运用CPS云物联技术，以标准化柜体形式提供整机系统，能将物品进行识别，暂存，监控和管理的设备。其由嵌入式智能主控系统与配套硬件，平板触摸屏/手机端前端操作界面，主机柜体，以及云端管理后台组成。嵌入式智能主控系统与配套硬件主要负责与云端进行双向通讯，数据处理等内部云计算，前端兼容触摸屏及手机端多模操作，云端管理后台提供管理员对设备进行远程监管，远程控制柜体箱格，业务数据汇总，用户信息统计等多方面的管理功能。公司内部可应用于同事间或部门与部门间的物料流转。例如部门A将资料文件放入周转柜，指定给部门B，部门B收到信息通知后，部门B的同事去周转柜取走资料文件。自助存取，大大节省人力成本。存物时箱格自动分配，并有消息提醒；取物时使用手机操作，方便快捷。

The Intelligent Circulation Storage Box is a device based on the Internet of Things, which uses CPS cloud IoT technology to provide a complete system in the form of a standardized cabinet, which can identify, temporarily store, monitor and manage items. It consists of an embedded intelligent main control system and supporting hardware, a flat touch screen/mobile front-end operation interface, a host cabinet, and a cloud management background. The embedded intelligent main control system and supporting hardware are mainly responsible for two-way communication with the cloud, internal cloud computing such as data processing, front-end compatible with touch screen and mobile terminal multi-end operation, cloud management background provides administrators to remotely supervise the device, remote control cabinet box Management functions such as grid, business data aggregation, user information statistics, etc.

### PRODUCT FEATURES

### 产品特点

- Internal Storage service between the employees inside the company
- External intelligent logistics services between logistics couriers and employees
- Unmanned management, self-service access, saving labor costs
- The storage compartment is automatically assigned with a message reminder
- Taking out the cargo via mobile phone

- 能够支持员工与员工间的物品周转服务流程的内部周转业务场景
- 支持物流快递员与员工间的智能物流服务的 外部物流周转业务场景(快递)
- 实现无人化管理，自助存取，大大节省人力成本
- 存物时箱格自动分配，并有消息提醒
- 取物时使用手机操作，方便快捷

#### 具体流程图如下： Operating procedures

#### 智能周转柜-存物

##### 员工存物 For employees use (Deposit)



##### 快递员存物 For logistics couriers use (Deposit)

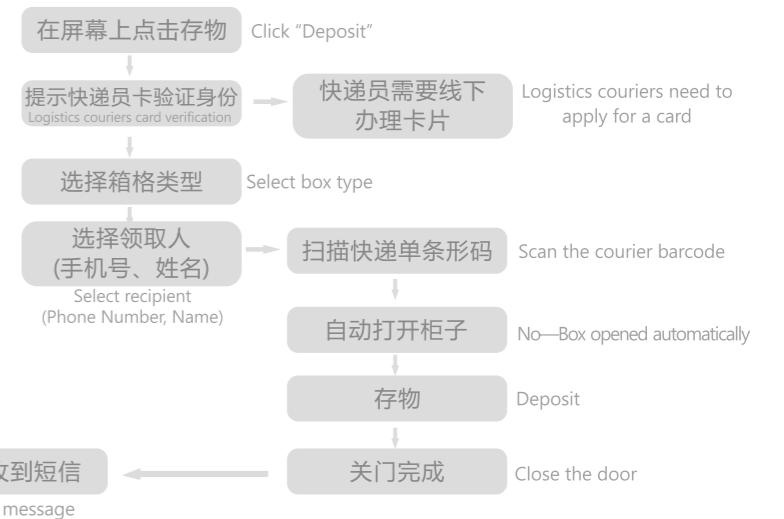

#### 智能周转柜-取物 Pickup

##### 方式一 Method One



##### 方式二 Method Two



说明：  
取物屏是的取件码  
60s刷新一次  
Noted: Refresh the Pickup Barcode in 60 seconds

型号 Model	名称 Name	规格 Specification
JT-ZN-ZZ-01	智能周转柜-主柜 Intelligent Circulation Storage Box—Main Unit	850W×450D×2050H
JT-ZN-ZZ-01	智能周转柜-副柜 Intelligent Circulation Storage Box—Add-on Unit	500W×450D×2050H

# INTELLIGENT CABINET SERIES- Intelligent Letter Box

## 智能柜系列-智能信报柜

### PRODUCT FEATURES

### 产品特点



具体流程图如下: Operating procedures

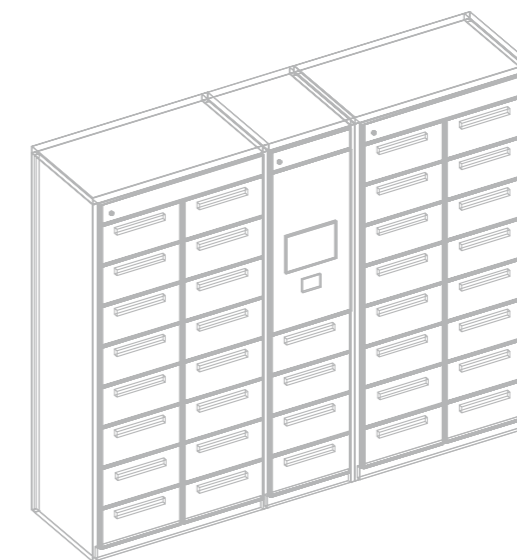
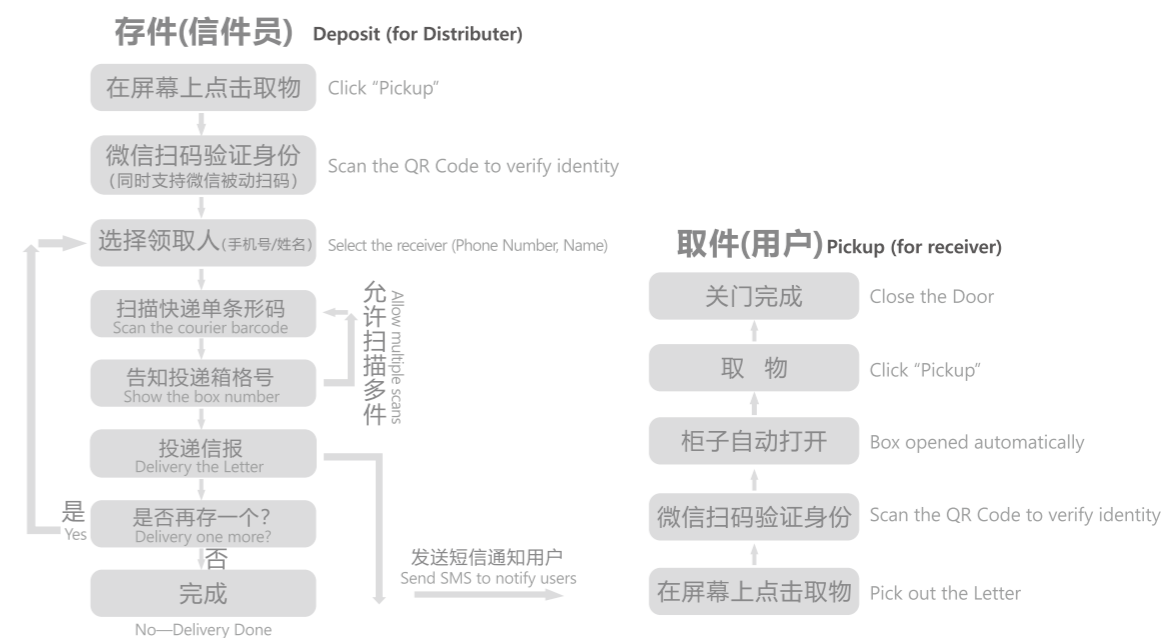

智能信报箱，供用户接收信件、报刊及其他邮件的通过使用智能系统实现简化操作的箱体。避免信件员派件时用户没空领取而造成错过重要文件的情况。

相对于传统信报箱，极酷智能信报箱在原有基础上能够系统化的整理信件并能及时通知用户取件，不像传统信报箱一般，用户要么忘记取件，要么忘记带钥匙无法开箱；只需要带上手机，就能够实现取件的操作。

Intelligent Letter Box is for the receiver to receive letters, newspapers and other mails via the cabinet that simplifies operation by using an intelligent system. Avoid missing important documents situation when the letter is arrived but the receiver is not available on that moment.

Compared with the traditional letter box, the Intelligent Letter Box can systematically organize the letters on the basis of the reason and can promptly notify the receiver to pick up the letter. Unlike the traditional letter box, the user either forgets to pick up the letter or forgets to bring the keys, and then it cannot open the box. For Intelligent Letter Box, just need to bring the mobile phone, then you can achieve the pickup operation.

型号 Model	名称 Name	规格 Specification
JT-ZN-XB-01	智能信报柜-主柜 Intelligent Letter Box—Main Unit	850W×450D×2050H
JT-ZN-XB-01	智能信报柜-副柜 Intelligent Letter Box—Add-on Unit	500W×450D×2050H



# INTELLIGENT CABINET SERIES-IMINI WAREHOUSE

## 智能柜系列-迷你仓

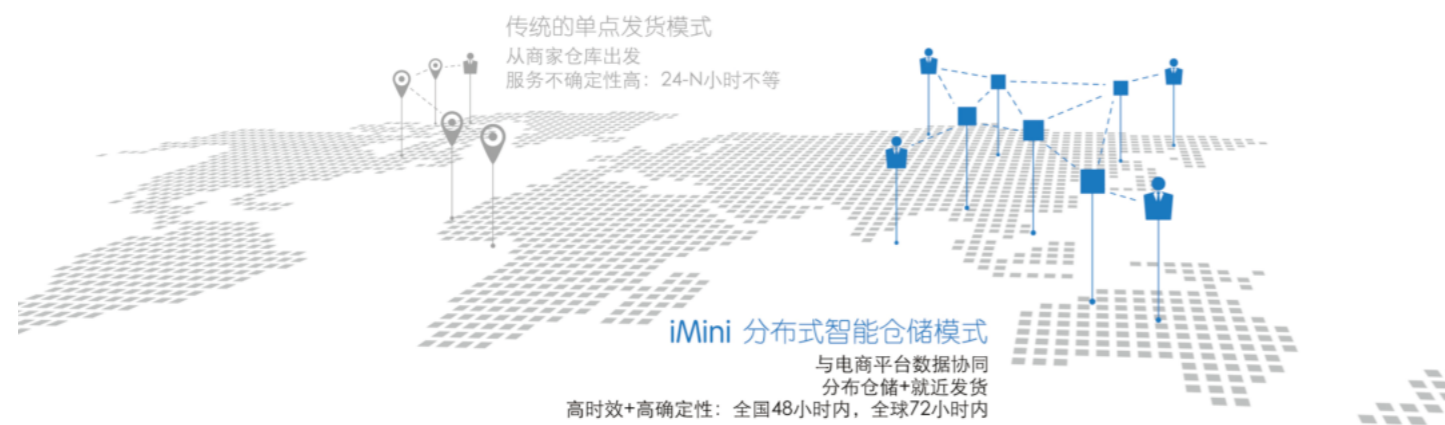

### PRODUCT FEATURES

### 产品特点

迷你仓也叫自存仓, 是储存物件的小型仓库。经营者将大型仓库改装分隔成若干间小仓库, 或者放入一排排的储物柜。

Mini warehouse is also called the silo, small warehouse is to store objects. The operator will be converted into several small warehouse space, a large warehouse Or in rows of lockers.

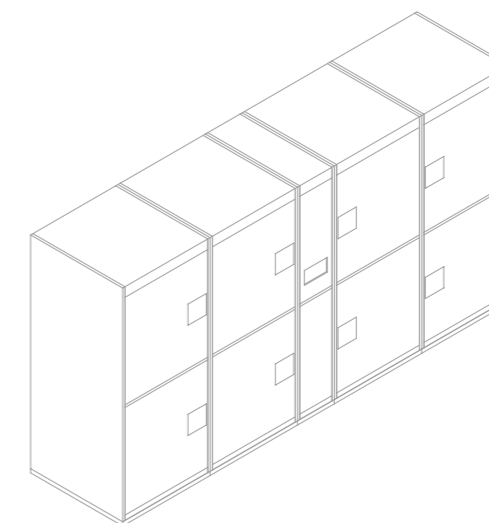
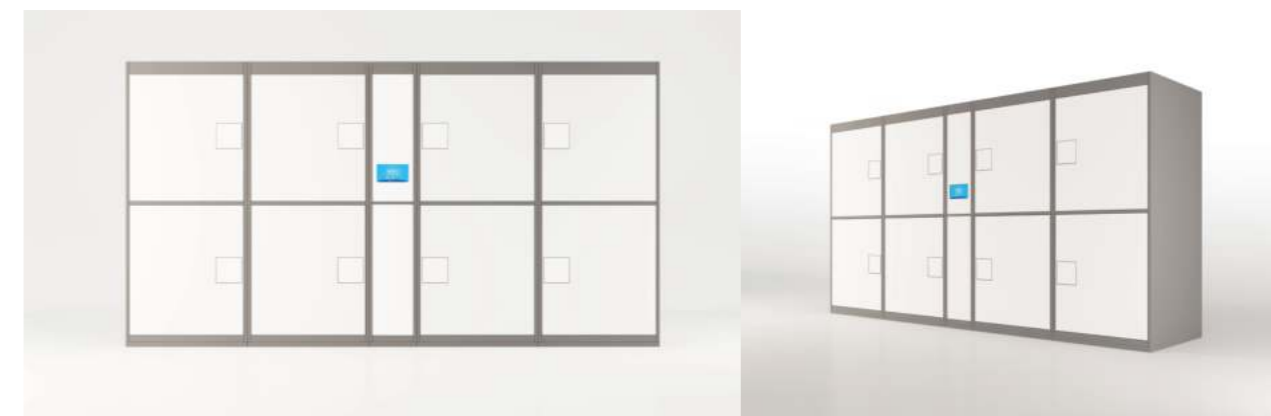

JT-MN-B/H

型号 Model	名称 Name	规格 Specification
JT-MN-B	智能迷你仓 Imini Warehouse	2280W × 1000D × 2240H
JT-MN-H	智能迷你仓 Imini Warehouse	2280W × 1000D × 2240H



FILE CABINET SERIES-COMPOSITE APPLICATIONS  
文件柜系列 组合应用



智能柜

文件柜

衣柜储物柜

图书柜

密集柜

公寓床/货架



**FILE CABINET-ACCESSORIES**  
文件柜系列-产品配件



随心定制不同拉手、普通锁、密码锁、色彩、尺寸和样式，让办公搭配不受约束。  
Customize different handles, ordinary locks, password locks, colors, sizes and styles to make the office match unconstrained.



绿色水晶拉手  
Green crystal handle

白色水晶拉手  
White crystal handle

塑料内凹拉手  
Plastic indent handle

铝拉手  
Aluminum handle

**PRODUCT PARTS**

**产品配件**

采用环保无毒害，无气味，产品稳重、坚固，外型设计美观、高端，展现时尚大气的现代美感！  
Our products are environmentally friendly, non-toxic, odorless, stable, sturdy, aesthetically pleasing, high-end, and showing the modern beauty of the atmosphere.

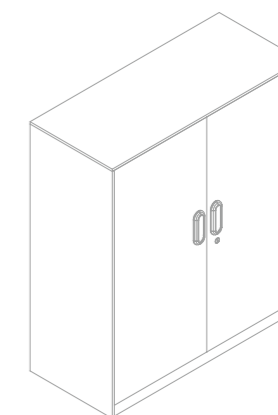

铜芯锁、折叠锁、品牌订制、质量保证。  
There are many locks for optional, such as copper core lock, folding lock, brand customization, with good quality assurance.



## FILE CABINET—LOWER CABINET 文件柜系列-矮柜



冷轧钢柜体，层板空间可调节，柜体防腐蚀能力强，多层工序制作抗磨损，颜色可定制。柜门拉手有多种选择。有对开门，三抽组合，对向移门，卷帘门等款式。外在线条充满视觉美，内在功能灵活实用，应尽直挂、横挂文件之需，极富时代感及领先风范。

The cabinet is made of Cold-rolled steel, shelf can be adjustable, and has good corrosion protection. Size, handles and color can be customized. There are many different types for selection, such as double door cupboard, drawer cabinet, sliding door cabinet, rolling door cabinet, etc... It has very nice appearance and very functional.

### PRODUCT FEATURES

### 产品特点

- Anti-tilt system
- Central locking
- Loading capacity: 45 kilos per drawer
- Foolscap, A4 or letter sized filing, easy take-out or put-in
- Two different drawer fronts

- 具备自锁功能
- 中央锁设计
- 每个柜桶载重可达 45kg
- 可选择悬挂 A3, A4、美式小文件夹
- 配备两款柜桶面板，任君选择

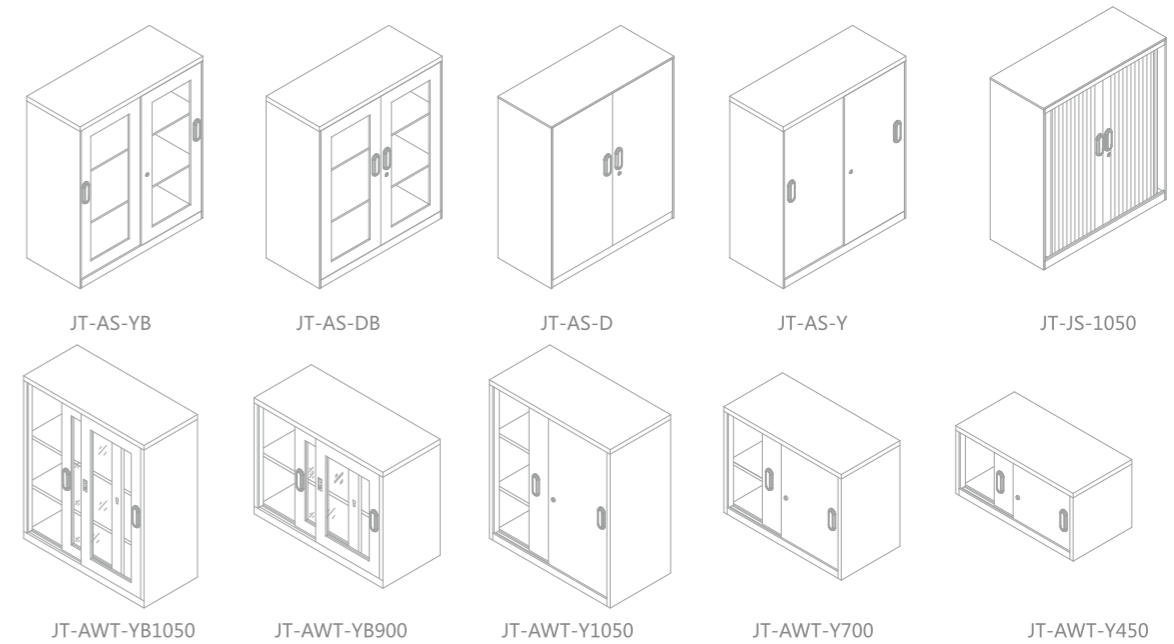

型号 Model	名称 Name	规格 Specification
JT-AS-YB	玻璃门移门矮柜 Glass sliding door cabinet	900W × 450D × 1050H
JT-AS-DB	玻璃门对开门矮柜 Glass door storage cabinet	900W × 450D × 1050H
JT-AS-D	对开门矮柜 Storage Cabinet	900W × 450D × 1050H
JT-AS-Y	移门矮柜 Sliding Door lower Cabinet	900W × 450D × 1050H
JT-JS-1050	卷帘矮柜 Rolling Door lower Cabinet	900W × 450D × 1050H
JT-AWT-YB1050	玻璃门移门矮柜 Toughened glass sliding door cabinet	900W × 450D × 1050H
JT-AWT-YB900	玻璃门移门矮柜 Toughened glass sliding door cabinet	900W × 450D × 900H
JT-AWT-Y1050	移门矮柜 Sliding door cabinet	900W × 450D × 1050H
JT-AWT-Y700	移门矮柜 Sliding door cabinet	900W × 450D × 700H
JT-AWT-Y450	移门矮柜 Sliding door cabinet	900W × 450D × 450H



## FILE CABINET— HIGHER CABINET

### 文件柜系列-高柜



冷轧钢板架体，表面磷化处理，防腐蚀。整体美观、大气，坚固耐用，抗打磨能力强，有宽边结构、外悬门结构、薄边结构。柜内层板可自由调节高度，柜门拉手有多种选择，有对开门，三抽组合，对向移门，卷帘门等款式。可根据客户需求灵活组合。

The cabinet is made of Cold-rolled steel, shelf can be adjustable, and has good corrosion protection. Size, handles and color can be customized. There are many different types for selection, such as double door cupboard, drawer cabinet, sliding door cabinet, rolling door cabinet, etc... It has very nice appearance and very functional.

## PRODUCT FEATURES

## 产品特点

- Designed with high anti-theft password
- Crystal handle design, beautiful lines, high-end
- Accessories can be customized
- The plastic strip of rolling door cabinet can be replaced

- 采用高防盗密码锁设计
- 水晶拉手设计，线条美观、高端
- 配件可随心定制
- 卷门柜塑料胶条可更换

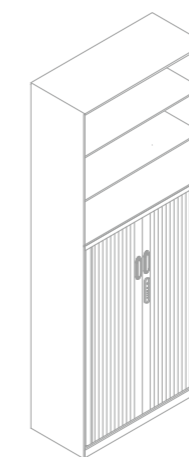

型号 Model	名称 Name	规格 Specification
JT-GZ-J-01	高柜 Higher Cabinet	900W × 450D × 2100H
JT-GZ-B-01	高柜 Higher Cabinet	900W × 450D × 2100H

**FILE CABINET— HIGHER CABINET**  
文件柜系列-高柜



**PRODUCT FEATURES**

**产品特点**

- Combination of HM and TM series
- Elegant and strong hinges open at 180 degree
- Ball bearing slides with full extension
- Loading capacity: 60 kilos per drawer
- Interchangeable functions

- HM 与 TM 系列文件柜的完美组合
- 配备高品质的加强门铰
- 配置滚珠轨道，柜桶全拉出
- 每个柜桶载重可达 60kgs
- 功能千变万化

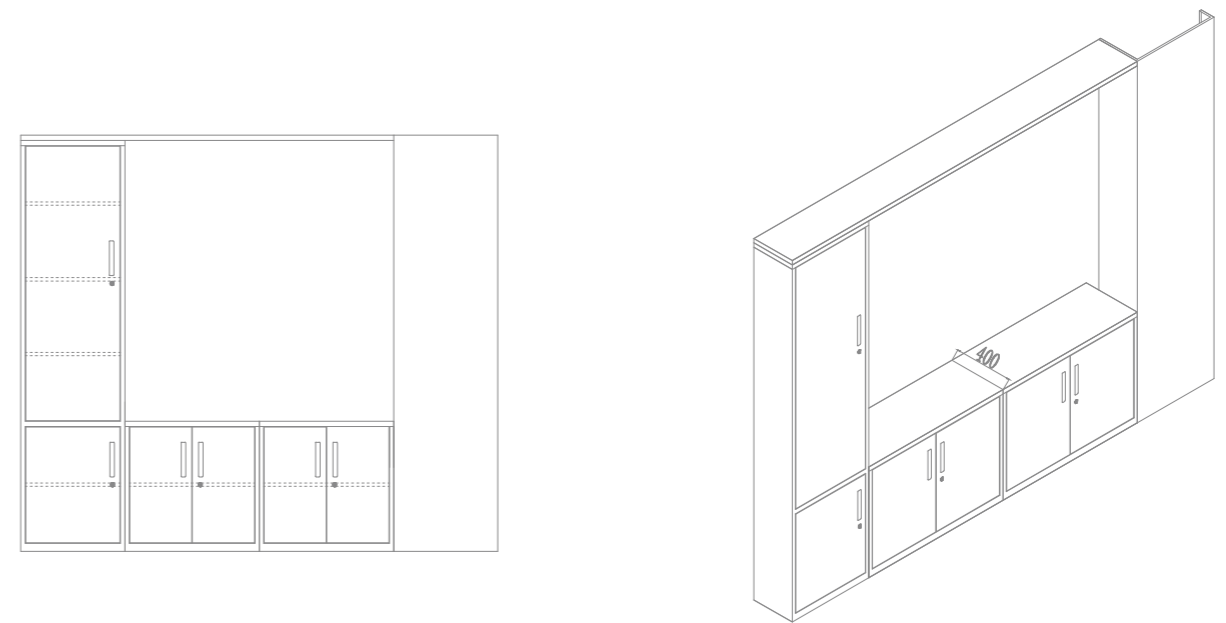

**TV CABINET**

FILE CABINET— HIGHER CABINET



**FILE CABINET— HIGHER CABINET**  
文件柜系列-高柜



LISTEN TO THE  
**QUALITY**

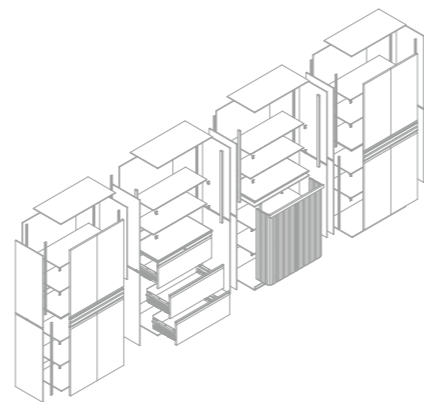

**PRODUCT FEATURES**

**产品特点**

- Combination of HM and TM series
- Elegant and strong hinges open at 180 degree
- Ball bearing slides with full extension
- Loading capacity: 30 kilos per drawer
- Interchangeable functions
- The file can be hangable on the draw

- HM 与 TM 系列文件柜的完美组合
- 配备高品质的加强门铰
- 配置滚珠轨道，柜桶全拉出
- 每个柜桶载重可达 30kgs
- 功能千变万化
- 抽斗可挂文件

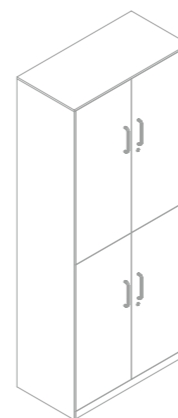

JT-GU-001

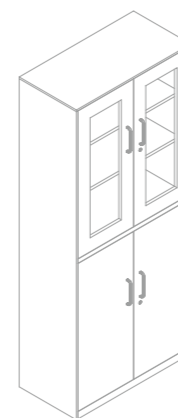

JT-GU-002

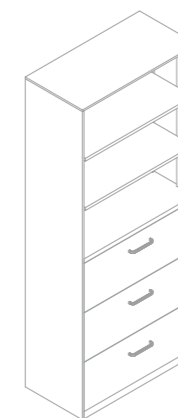

JT-GU-003

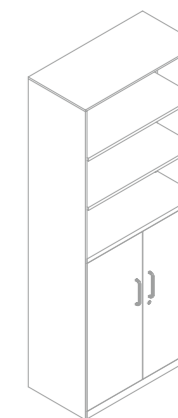

JT-GU-004

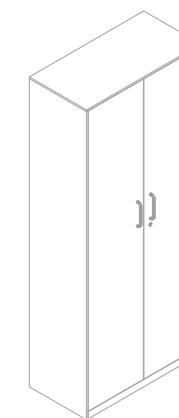

JT-GU-005

型号 Model	名称 Name	规格 Specification
JT-GU-001	双掩门高柜 Double door cabinet	900W × 450D × 1850H
JT-GU-002	玻璃门双掩门高柜 Double glass door cabinet	900W × 450D × 1850H
JT-GU-003	无门三抽高柜 Non door high three drawer	900W × 450D × 1850H
JT-GU-004	无门双掩门高柜 Non door high cabinet	900W × 450D × 1850H
JT-GU-005	双掩门高柜 Double door cabinet	900W × 450D × 1850H

# FILE CABINET SERIES –PEDESTAL CABINET

## 文件柜系列-活动柜



拉手、配色，可能随心定制，时尚简约搭配！  
Handle, color, can be customized, stylish and simple



白砂	Frosting White	D13221
哑光白	Matte White	E1483
闪银灰	Shining Silver Grey	GE79527
半光灰	Semi-gloss Gray	E7047
炭灰色	Charcoal Grey	E2166
黑砂	Frosting Black	D228
黄砂	Frosting Yellow	D1026
橙色	Semi-gloss Orange	E82004
哑光红	Matte Red	E3028
浅蓝色	Semi-gloss Light Blue	E5012

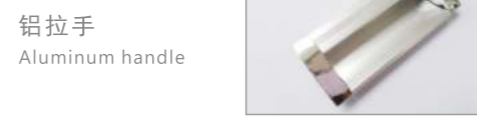
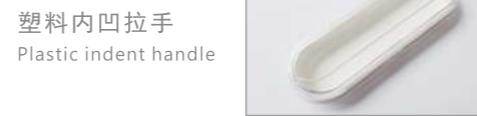
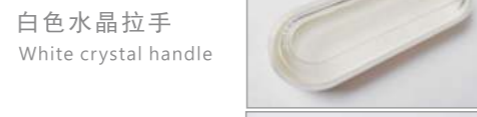

### PRODUCT FEATURES

### 产品特点

安装简易。具备自锁功能，中央锁设计。柜桶均可全拉出，每个柜桶载重可达45kg。可悬挂A3、A4、美式小文件夹。配备两款柜桶面板，任君选择。

File cabinet serious—Tambour cabinet  
Knock down structure, simply installation. With self-locking function, central lock design. The drawers could be pull out totally, each drawer can loading more than 45kg. it is suitable for the vertical A3、A4 and small American Folder. Drawer & hanging frame for selection.

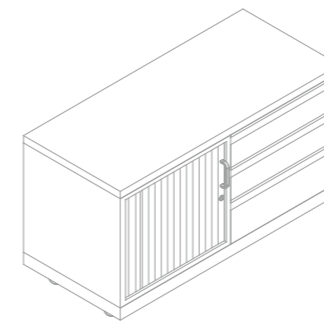

JT-FG-Z

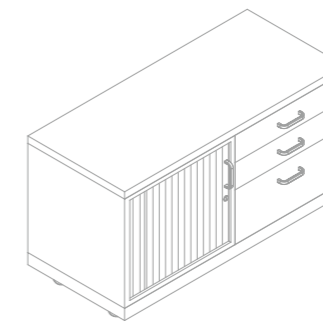

JT-FG-U

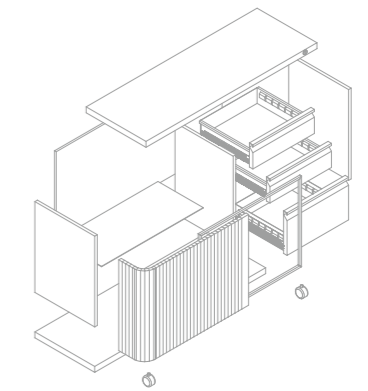

型号 Model	名称 Name	规格 Specification
JT-FG-Z	小推柜 Pedestal Cabinet	400W × 500D × 630H
JT-FG-U	坐地柜 Small drawer cabinet	400W × 500/550D × 725H



# FILE CABINET SERIES-ROLLING DOOR CABINET

## 文件柜系列-卷门柜



### PRODUCT FEATURES

### 产品特点

卷门塑料胶条可更换；设有水平调整装置，防止倾倒；间距25mm连排孔，方便灵活移动层板高度；门铰链经特别设计，使卷门可轻易拆除及安装；精粹与运用最少的空间创造最大的面积；外形美观、典雅、全新的设计。

Plastic strips can be replaced; horizontal adjustable device; 25mm separation space to adjust; hinges are special designed making it easier to remove or install; most space utilization; beautiful, graceful and unique design.

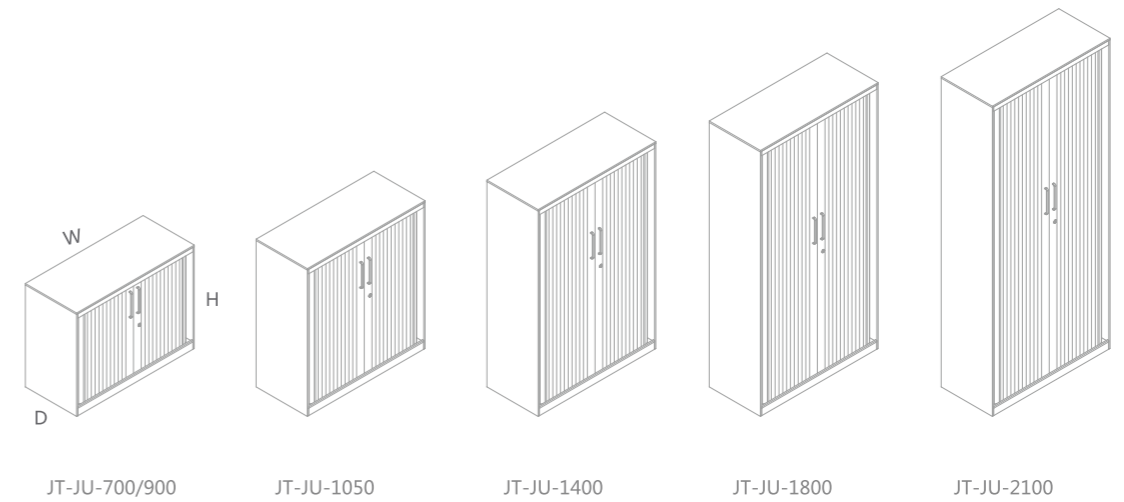

型号 Model	名称 Name	规格 Specification
JT-JU-900	卷门柜 Rolling Door Cabinet	900W × 450D × 900H
JT-JU-1200	卷门柜 Rolling Door Cabinet	900W × 450D × 1200H
JT-JU-1800	卷门柜 Rolling Door Cabinet	900W × 450D × 1800H

## FILE CABINET SERIES- LATERAL DRAWING CABINET

### 文件柜系列-横抽柜

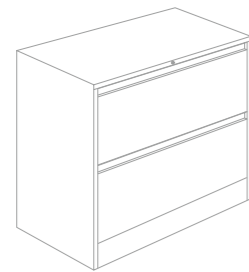

JT-HZ-720



JT-HZ-1100



JT-HZ-1400

型号 Model	名称 Name	规格 Specification
JT-HZ-720	横向两抽文件柜 2-drawer Lateral Filing cabinet	900W × 450D × 720H
JT-HZ-1100	横向三抽文件柜 3-drawer Lateral Filing cabinet	900W × 450D × 1100H
JT-HZ-1400	横向四抽文件柜 4-drawer Lateral Filing cabinet	900W × 450D × 1400H

## PRODUCT FEATURES

## 产品特点

- 选用冷轧钢板一次冲压成型；
- 喷淋前处理,系统喷涂前所有部件全部经过处理,确保表面不含油污及锈蚀；
- 焊接采用数码电焊机及二氧化碳保护焊接,确保工件的焊接强度及焊接平整光滑；
- 静电喷塑粉系统以及电子控温燃油固化系统,确保工件受热均匀,塑粉附着力强环保无污染。
- 表面涂层坚固耐用,耐冲压,耐腐蚀,整洁美观,不易燃、防潮不变形。
- 上下左右搭配组合,可无限延伸。

- Cold rolling steel plate is used for one-time forming.
- Pre-spray treatment, all parts of the system are processed before spraying, which ensure the surface is free of oil and corrosion.
- Welding is performed by digital welding and carbon dioxide protection welding to ensure the welding strength and smooth welding of the work.
- The electrostatic spray powder system and the electronic temperature-controlled fuel curing system ensure that the work is evenly heated, the spray powder has strong adhesion, and is environmentally friendly.
- The surface coating is durable, resistant to stamping, corrosion-resistant, neat and tidy, non-flammable, moisture-proof and non-deformable.
- Combination of up, down, left and right, wireless extension.

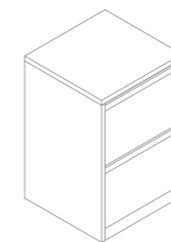

JT-KZ-700



JT-KZ-1100

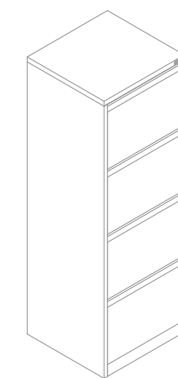

JT-KZ-1400

型号 Model	名称 Name	规格 Specification
JT-KZ-700	两桶文件柜 2-drawer Vertical Filing cabinet	470W × 450D × 700H
JT-KZ-1100	三桶文件柜 3-drawer Vertical Filing cabinet	470W × 450D × 1100H
JT-KZ-1400	四桶文件柜 4-drawer Vertical Filing cabinet	470W × 450D × 1400H



## FILE CABINET SERIES-DRAWING CABINET

### 文件柜系列-图纸柜



## PRODUCT FEATURES

## 产品特点

柜体采用优质冷轧钢，通过酸洗磷化防锈处理。高温静电粉末喷塑，环保无毒害，无气味，产品稳重、坚固；为档案图纸储存的首选产品。

按标准A型图纸大小一般可分为0号底图柜、1号底图柜、2号底图柜等，柜体采用抽屉式结构，根据时间图纸型号选用合适的图柜。

The cabinet is made of high quality cold rolled steel. And through pickling, phosphating, passivation, surface pre-treatment and standard electrostatic spraying, it is anti corrosion, rust-proof and durable. It is the best choice for the drawings.

The drawings is divided into 3 types, #0, #1 and #2 according to Type A drawings. It is easy to mark out the time and model of drawing because it uses the drawer type structure.

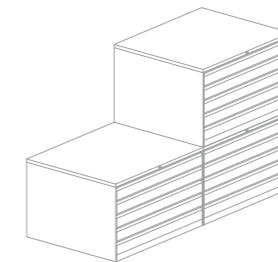

JT-TZ-A0

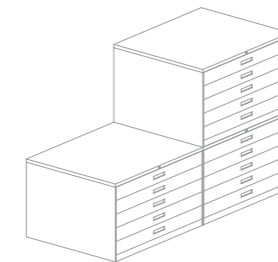
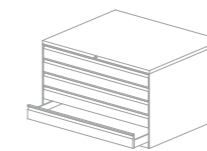

JT-TI-A1



型号 Model	名称 Name	规格 Specification
JT-TZ-A0	图纸柜 Drawing Cabinet	1300W × 950D × 550H
JT-TI-A1	图纸柜 Drawing Cabinet	980W × 750D × 550H

# LOCKER/ WARDROBE 衣柜/储物柜系列



铜芯锁、折叠锁、品牌订制、质量保证。

The cabinet is made of Cold -rolled steel, shelf can be adjustable, and has corrosion protection .Size,handles and color can be customized. It has many different lock, such as copper core lock, folding lock, brand customization, with good quality assurance.



## PRODUCT FEATURES

## 产品特点

- High quality cold-rolled steel, more durable
- Phosphate surface treatment, acid and corrosion resistance
- With 4 combination number lock, more safe and convenience
- With linear design, more beautiful and high-class
- Interior shelves adjustable
- Professional and experienced Production Processes
- Handles and locks are optional
- With ventilation in the door
- label handle and other accessories are optional
- Color is optional
- With hanging rod, layer shelf
- KD Structure
- Company's regular locks, handles be customized

- 选用优质冷轧钢板，更坚固耐用
- 表面磷化处理，耐酸碱，防腐蚀
- 4位机械锁，更安全
- 整体线条设计，尽显高端大气
- 内部层板可自由调节高度
- 多道工序流水精工制作
- 门锁，拉手可自由选配
- 门板配备透气孔
- 各种配件类：标签座、拉手等随心配备
- 颜色可选
- 可挂衣、有层板
- 可做拆装
- 可订做本公司的常规锁、扣手

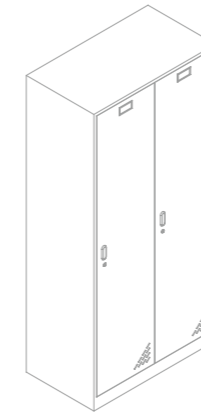

JT-YS-2

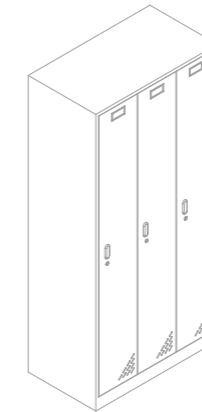

JT-YS-3

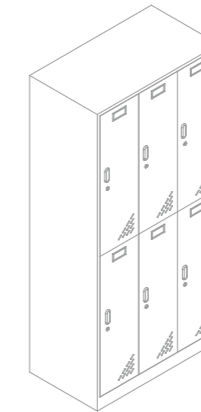

JT-YS-6

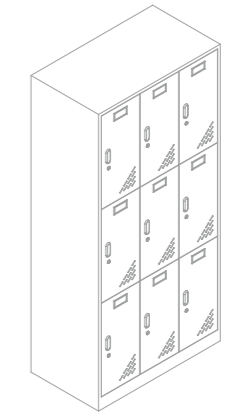

JT-YS-9

型号 Model	名称 Name	规格 Specification
JT-YS-2	水晶拉手2门衣柜 Crystal handle 2 door wardrobe	900W × 500D × 1900H
JT-YS-3	水晶拉手3门衣柜 Crystal handle 3 door wardrobe	900W × 500D × 1900H
JT-YS-6	水晶拉手6门衣柜 Crystal handle 6 door wardrobe	900W × 500D × 1900H
JT-YS-9	水晶拉手9门衣柜 Crystal handle 9 door wardrobe	900W × 500D × 1900H



## LOCKER/ WARDROBE 衣柜/储物柜系列



## PRODUCT FEATURES

## 产品特点

- High quality cold-rolled steel, more durable
- Phosphate surface treatment, acid and corrosion resistance
- With 6 combination number lock, more safe and convenience
- With linear design, more beautiful and high-class
- Interior shelves adjustable
- Professional and experienced Production Processes
- Handles and locks are optional
- With ventilation in the door
- label handle and other accessories are optional
- Color is optional

- 选用优质冷轧钢板，更坚固耐用
- 表面磷化处理，耐酸碱，防腐蚀
- 6位机械锁，更安全
- 整体线条设计，尽显高端大气
- 内部层板可自由调节高度
- 多道工序流水精工制作
- 门锁，拉手可自由选配
- 门板配备透气孔
- 各种配件类：标签座、拉手等随心配备
- 颜色可选

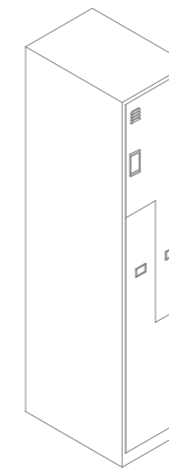

JT-YS-2

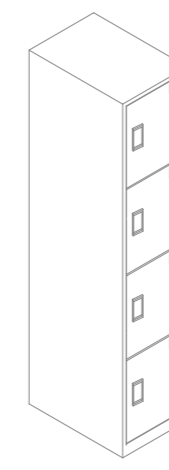

JT-YWT-3

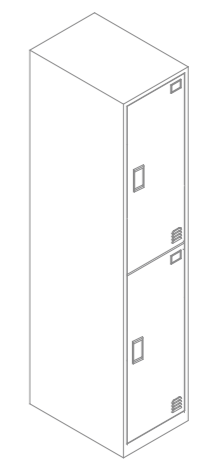

JT-YWT-2

型号 Model	名称 Name	规格 Specification
JT-YS-2	二门衣柜 Two door wardrobe	400W × 500D × 1800H
JT-YWT-3	四门储物柜 Four-door locker	400W × 500D × 1800H
JT-YWT-2	二门储物柜 Two-door locker	400W × 500D × 1800H

# BOOKSHELF 书架

## PRODUCT FEATURES

## 产品特点

### 防火板双立柱书架

底座钢结构，双立柱带可调节孔，层板高度可任意调节。全拆装，可配木侧护板、木顶板、木裙角。侧板冲孔减重并带有标牌镶嵌框，方便管理。层板中间设有档条，使两侧文件互不干涉，按库房管理高度可以选配书架层数。

### Fire-proof double column bookshelf

Steel Base, double column with adjustable holes, inner shelves can be adjustable, fully Knocked-down design. It can be decorated with MDF panel on front, top and bottom. The front panel with label, management more easy. There is a stopping strip between two layer shelves to avoid mixing files between two shelves. The size of bookshelves can be customized according to the room size.



Model : JT-ZZ-2100  
Name : 单面杂志架 Single Magazine rack  
Size : 900W × 450D × 2100H

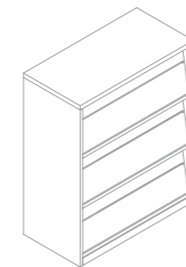

Model : JT-ZZ-1050  
Name : 单面杂志架 Single Magazine rack  
Size : 900W × 450D × 1050H

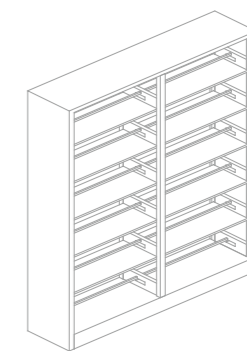

Model : JT-TS-2000  
Name : 双面书架 Double side shelf  
Size : 1900W × 450D × 2000H



### 钢制双立双面存放书架

底座钢结构，双立柱带可调节孔，层板高度可任意调节。全拆装，侧板冲孔减重并带有标牌镶嵌框，方便管理。层板中间设有档条，使两侧文件互不干涉，按库房管理高度可以选配书架层数。

### Steel double column double side bookshelf

Steel Base, double column with adjustable holes, inner shelves can be adjustable, fully Knocked-down design. It can be decorated with MDF panel on front, top and bottom. The front panel with label, management more easy. There is a stopping strip between two layer shelves to avoid mixing files between two shelves. The size of bookshelves can be customized according to the room size.





## TYPE COMPACT SHELF SYSTEM

### 手动密集架

使用优质冷轧钢板设计，更坚固耐用  
柜体之间设有防撞装置  
卓越的承重能力加大了存储量，更节约空间  
结构精加工处理，层板之间可以自由调节  
人性化设置：顶部防尘板+底部防鼠板+架体防倾倒设计  
可按实际需求进行设计定制，十年保修

- Using high quality cold-rolled steel plate for design, more durable
- Between each row with anticollision device
- Excellent loading capacity to increase the storage quantity to saving more space .
- Sepcial structure design ,Shelves can be adjustable freely
- Humanized setting : dustproof top plate+ ratproof divice at bottem + anti-tilting device for
- Can be customized according to the actual demand, ten years warranty

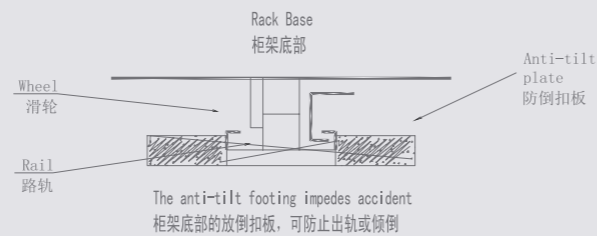

## 3 COLUMN TYPE COMPACT SHELF SYSTEM

## PRODUCT FEATURES

## 产品特点



机械式移动密集文件架 (柜) Mechanical Compact Shelf

NUMBER OF BAYS	WIDTH	SINGLE FIXED	SINGLE MOVABLE	DOUBLE MOVABLE 双面移动架		
				560D	650D	760D
1	1065	SF450-1	SM450-1	DM560-1	DM650-1	DM760-1
2	1965	SF450-2	SM450-2	DM560-2	DM650-2	DM760-2
3	2865	SF450-3	SM450-3	DM560-3	DM650-3	DM760-3
4	3765	SF450-4	SM450-4	DM560-4	DM650-4	DM760-4
5	4665	SF450-5	SM450-5	DM560-5	DM650-5	DM760-5
6	5565	SF450-6	SM450-6	DM560-6	DM650-6	DM760-6

HEIGHT 高度 2150mm    WIDTH 宽度 (900xN)+165mm    N 联数: NO. of Bays

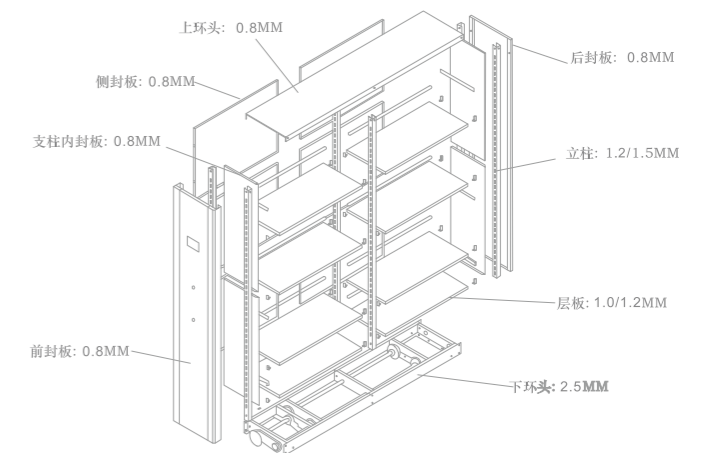
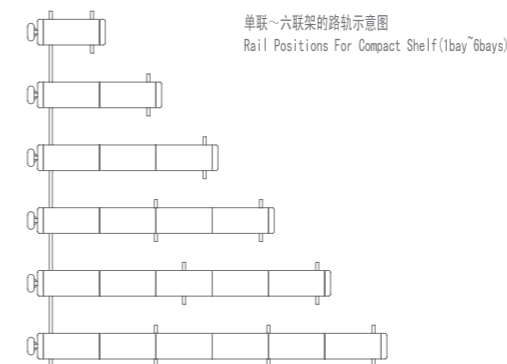
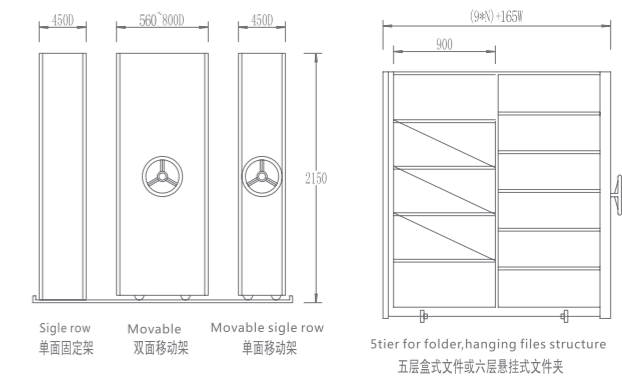

# SPACE LIBERATION

空间解放者



智能密集架在档案管理的计算机界面上可开启或关闭密集架电源，不用工作人员来回奔忙，而管理计算机可设置于客户需要的任何地方；通过密码权限对档案密集架进行操作。

**密集架分类/Shelves classification**

根据内部结构：立柱式、半封闭式、全封闭式、悬挂式、油画式、底图柜式。

根据驱动方式：手动密集架、电动密集架、智能密集架。

根据颜色：套色、木纹转印

The power can be open or closed by oprating to the interface of the computer. The computer can be placed anywhere needed. The operation can be realised by get penmission of the password.

**Internal structure classification:**column type,semi-close type, full-closed type ,manual shelving type,oil painting type,drawing type,

**Driving mode:**manual shelving,electric shelving,intelligent shelf.

**Color:**topping wooden transfer.

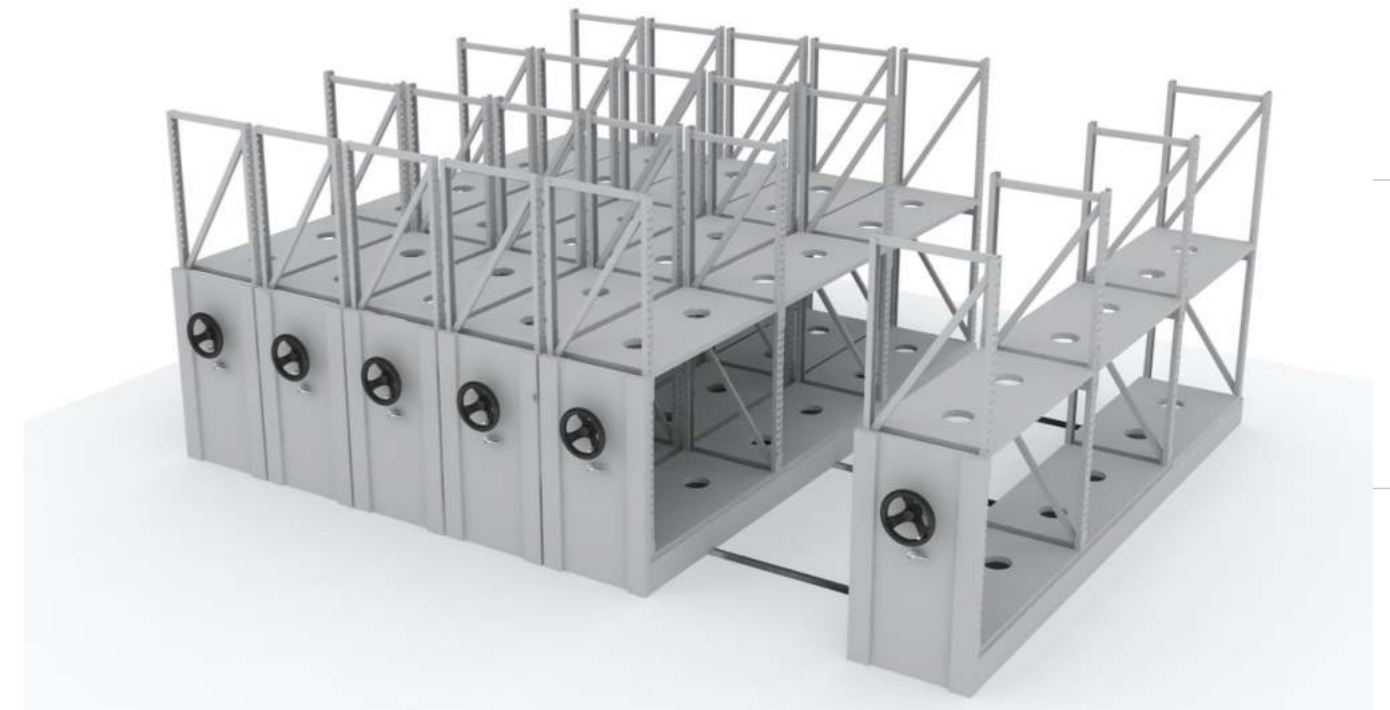

PRODUCT FEATURES

产品特点



- 可安装
- 带水管装置
- 可移动
- 原材料镀锌板, 户外粉
- 优选材质防止生锈

- KD structure
- Install with Water Pipe
- Movable system
- Raw material: Galvanize Steel
- Waterproof Powder Coating, Anti- rusty.



## MOBILE STORAGE RACK 移动货架

### 密集货架

同样的房间使用面积情况下，密集货架的储存量比普通货架储存量的两倍以上；

架体之间设计有缓冲密封条。密封条采用永磁抗老化的塑胶，结合紧密，不变形，不脱落，架体合拢后两侧良好密封，合拢时起缓冲作用；

每列设有锁紧装置，当工作人员进入架体工作时，将锁紧装置扭到锁紧位置，此时其他人员无法摇动架体，以保证架内人员的安全。每组密集货架边列装有锁具，其闭合后，用锁锁住后，形成一个封闭的整体；

每列设有防倒装置，在底盘的下方固定有防倒钩，在正常运行时防倒钩与轨道灯间隙滑动，当货架收到倾斜力时，通过底盘上的防倒钩将力传到轨道上，并通过联接轨道与地面的膨胀螺栓钉传到地面，以保证架体不倾斜。

### Mobile shelf

In the case of same area, the mobile shelf storage capacity is twice as the ordinary storage shelf.

The sealing strip is installed between the shelves. The sealing strip is made of permanent magnet plastic, are designed to absorb some of the impact.

Each line is provided with a locking device. when the staff enter, lock the brake to keep the safety of the staff. Each group of the shelf has a side lock. when it is closed and lock become a closed model.

Each line is equipped with an anti tilting devices on the base, to prevent dumping.

## PRODUCT FEATURES

## 产品特点



智能柜

文件柜

衣柜  
储物柜

图书柜

密集柜

移动货架

**WAREHOUSE STORAGE RACKING**  
货架



Name : JT-HJ-50  
Size: 1800W × 500D × 2000H



**PRODUCT FEATURES**

**产品特点**



Name : PR 四层重型货架  
PR 4-storey heavy duty rack  
Size: 2000W × 1000D × 2000H

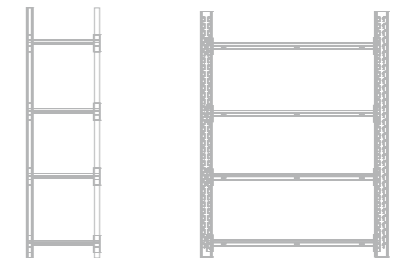

**轻型货架**

货架采用优质冷轧板冲压成型，经酸洗磷化处理，静电喷粉而成，外形美观，结构牢固，承重能力强，可随意组合，全拆装结构。

**Light Duty Rack**

Light Duty Rack is using steel stamping molding. Surface treatment process pickling, phosphating, spraying, high-temperature baking. It has the benefit of solid, strong bearing capacity and fully knocked-down structure.

智能柜

文件柜

衣柜储物柜

图书柜

密集柜

货架



## APARTMENT BED 公寓床



Model: JT-C-002  
Name: 单人多功能床  
Single-person Multi-functional bed  
Size: 2000W × 900D × 1750H

## PRODUCT FEATURES

## 产品特点

### 新型公寓床系列

公寓床是由床、书柜、衣柜、书桌和梯架等组成的一款为学校学生宿舍、工厂员工宿舍、建筑住宿等专门设计使用的床，并可随意组合。住宿学生的上下床有效的节省空间，同时解决校舍不足问题。

### New Style Apartment Bunk Bed Series

Apartment bed is specially designed for school dormitories, staff dormitories, building accommodations. It consists of bed, bookcase, wardrobe, desk and ladder. All of these parts can be combined freely. The newly bed can be space saving and solves the problem of inadequate dormitories.



Model: JT-C-001  
Name: 单人多功能床  
Single-person Multi-functional bed  
Size: 2000W × 900D × 1750H



# make a product as a Smart Manufacturer?

一件产品是如何智造的？

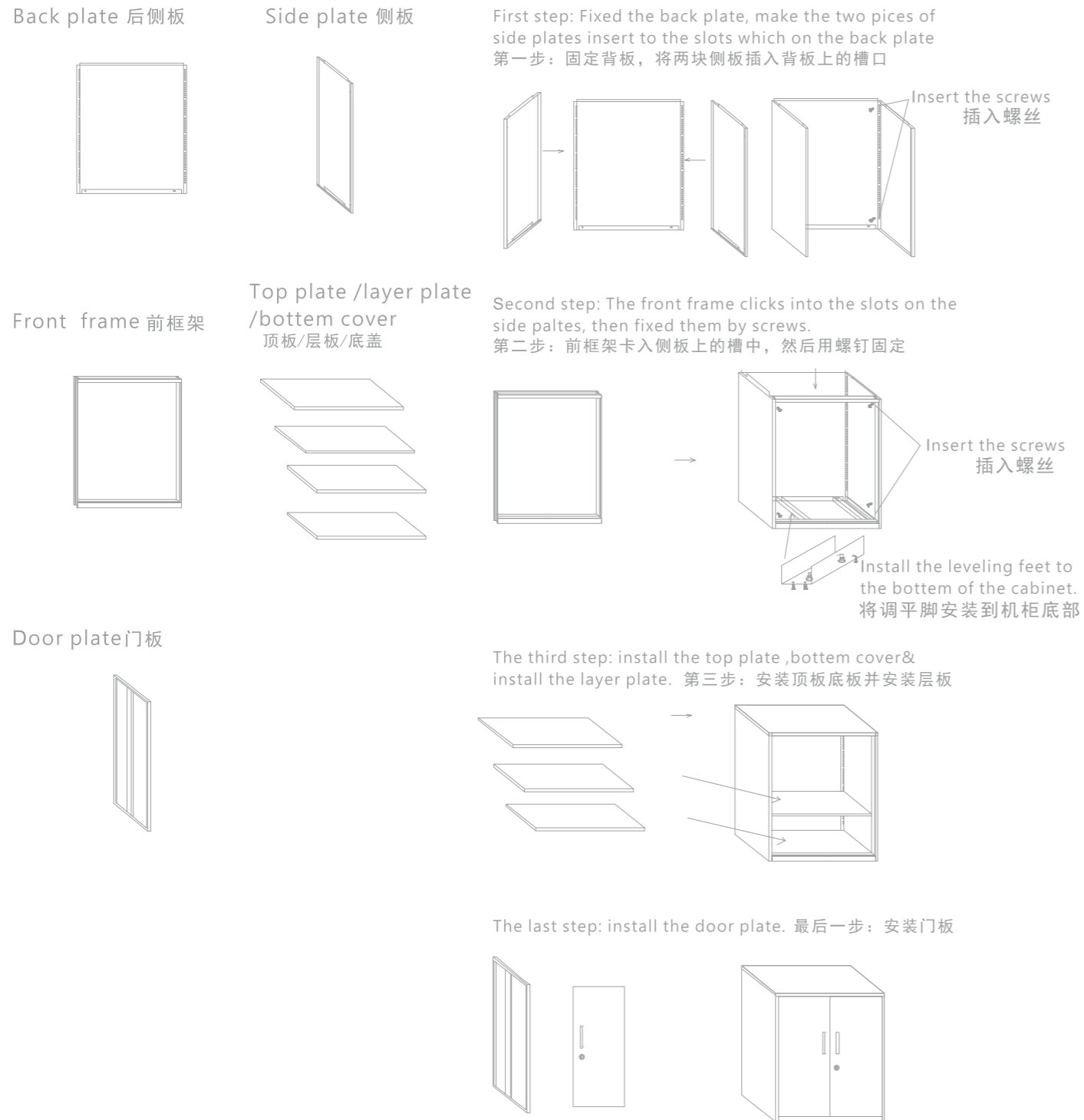

## Production process 产品生产工艺

采用对环境负责的处理方法,每一道工艺都经过精心细选,坚固不变形!

With the environmentally responsible treatment method, each process has been carefully selected, solid and not deformed!

- 设计 DESIGN
- ↓
- 采购材料 Purchase materials
- ↓
- 剪板 Cutting
- ↓
- 冲压 Punching
- ↓
- 成型 Shaping
- ↓
- 焊接 Welding
- ↓
- 打磨 Polishing
- ↓
- 喷涂 Spraying
- ↓
- 试装质检 Quality inspection
- ↓
- 安装包装 Installation and packaging
- ↓
- 入库 Stock-in





**对可持续生命周期的考虑：**键特产品的设计、使用、处理，无论从材料、生产、运输、使用直到生命周期结束对其产品的每个构成零部件，都进行了仔细的考虑，以减少对环境的影响。每个产品零部件的设计，从最初开始就融入了对环保的考虑，而不是一个后发的思考。

**材料：**简洁的结构及设计，有助减少原材料的应用及生产过程中的废料。我们认真研究材料的化学成分，选择安全健康的材料。为减少材料虚耗以及减轻对环境的影响，积极使用含有高比例可回收成分的材料(比如铝压铸及钢制部件)以及容易回收的材料（比如挤压铝、聚酯纺织品）。

**生产与包装：**产品设计将生产过程中的浪费、能源消耗以及对环境影响减至最低。所有钢制部件外表均由粉末覆盖，选用了阿克苏诺贝尔的绿色涂料产品。阿克苏诺贝尔是全球最大的油漆和涂料公司，拥有世界领先的技术。另外，键特的喷涂过程不含铅和有毒溶剂，没有任何有害的VOC（挥发性有机化学物），所有用过的粉体都得到重新利用或进行再回收。轻型的可拆卸包装可使材料的使用降到最低程度，并减少运输与分销过程中的能源消耗。

**生命周期结束：**设计周全的弃置策略，采取对环境负责的处理方法，包括再销售、翻新、回收或捐赠。为了实3Rs（减少、再利用、再循环），每个部件都易于拆卸，以便循环利用。

**Considering the sustainable life cycle:**

The design, use, processing from Jeanter, in order to reduce the impact on the environment, no matter from the material, the production, transportation, use until the end of the life cycle for each constitute part of products which all have a careful consideration. Each design of product's component, from the beginning is blended in consideration to the environmental protection, rather than the last to think.

**Row material:**

Simply structure and designs is good for save row material cost and to avoid more scrap material. We have carefully studied the chemical composition of the material to choose a safe and healthy type. We consider to improve utilization rate of material and environmental protection, we prefer to use the material which high proportion of recyclable components and easily recyclable, such as the Steel and aluminum die-casting parts.

**Production and packing:**

We already consider to reducing the production waste, energy consumption and environmental pollution during the production when we work on the designing. All steel components surface are covered with the environment-friendly powder coating from Akzo Nobel Chemicals Company. Akzo Nobel Chemicals Company is the world's largest paints and coatings company, has the world's leading technology. In addition, the spraying process from GZ Jeanter is without lead, poisonous solvents or VOC (volatile organic chemicals), all the coatings can be reused and recycled. Lightweight removable packaging can make the use of material to a minimum level, and to reduce the energy consumption in the process of transportation and distribution.

**Usage period:**

Researching the recycling strategies to make support environmental protection, including resale, refurbishment, Recycling or donation, In order to achieve 3Rs (reduce, reuse and recycle), each components is easily to disassemble for recycling.

**SERVICE HOTLINE**

服务热线

**SERVICE HOTLINE:**

**服务热线：**

**400-8720988**

**售后被动呼叫**

售后服务呼叫

**售后主动巡检**

售后外勤定期巡检

如需要更换配件

常备配件(2工作日)

非常备配件(5工作日)

维修人员 8 小时到场

如需要更换配件

常备配件(2工作日)

非常备配件(5工作日)