

DESIGN FOR LIFE



广州键特办公家具有限公司成立于2008年5月18日，注册资金1200万元。是一家集研发、设计、制造、销售于一体的金属设备服务企业。公司产品采用优质的冷轧钢板、镀锌钢板、电解板、不锈钢板等板材为原材料。制造的产品有普通型、机械性、电子型、智能型：档案存储设备，图书馆设备，仓储设备，办公设备，公寓设备，保险设备，物流储存设备，智能储存设备等。八大系列，上百种产品。

我们可以按客户实际需求给予免费设计，提供OEM服务：生产、售后，或品牌区域经销服务。企业服务宗旨：公司发扬以人为本，以德为先，创新发展，合作双赢的企业精神，与海内外各界朋友共创美好的明天！

Guangzhou Jeanter Office Furniture CO.,LTD. was founded on 18th, May 2008. With registered capital of 12 million RMB, it starts to be a service company of researching, designing, manufacturing and sale.

We use superior Cold-roll steel, Galvanized Steel Sheet, Electro-Galvanized Steel and Stainless steel sheet as our raw material.

We have the wide product line in Standard Office Furniture, Mechanical, Electronic and Intelligent Furniture which includes File Storage, Library Furniture, Warehouse Storage Furniture, Courier Cabinet and Intelligent Cabinet. In total eight series and covers hundreds of products.

We can provide free design according to actual needs of customers; provide OEM services: production, sale, or brand regional distribution services.

The company service principle: People Oriented, Morals Priority, Innovative Development, Win-win Cooperation!

FILE CABINET—LOWER CABINET 文件柜系列-矮柜



冷轧钢柜体，层板空间可调节，柜体防腐蚀能力强，多层工序制作抗磨损，颜色可定制。柜门拉手有多种选择。有对开门，三抽组合，对向移门，卷帘门等款式。外在线条充满视觉美，内在功能灵活实用，应尽直挂、横挂文件之需，极富时代感及领先风范。

The cabinet is made of Cold-rolled steel, shelf can be adjusted, and has corrosion protection. Size, handles and color can be customized. It has many different types for selection, such as 2 doors cupboard, drawer cabinet, sliding door cabinet, rolling door cabinet, etc..... It has very nice appearance also very functional.

PRODUCT FEATURES

- K.d.,easy assembly
- Anti-tilt system
- Central locking
- Loading capacity:45 kilos per drawer
- Foolscap,A4 or letter sized fling,easy take-out or put-in
- Two different drawer fronts

产品特点

- 拆装结构，安装简易
- 具备自锁功能
- 中央锁设计
- 每个柜桶载重可达 45kg
- 可选择悬挂 A3，A4、美式小文件夹
- 配备两款柜桶面板，任君选择

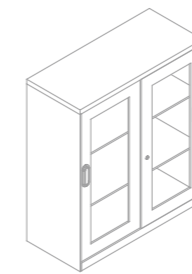

JT-AS-YB



JT-AS-DB

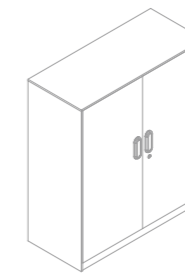

JT-AS-D

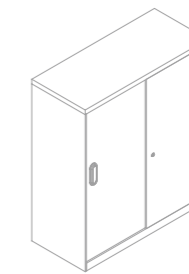

JT-AS-Y

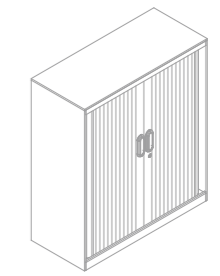

JT-JS-1050

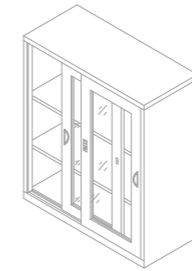

JT-AWT-YB1050

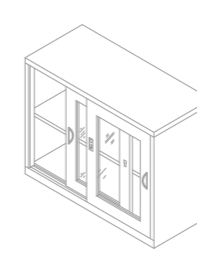

JT-AWT-YB900

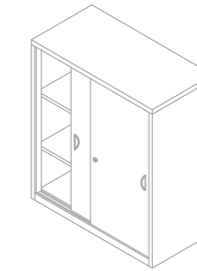

JT-AWT-Y1050

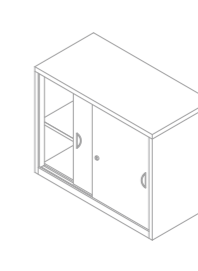

JT-AWT-Y700

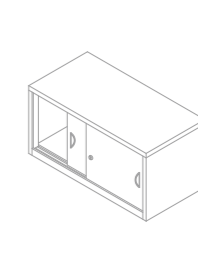

JT-AWT-Y450

型号 Model	名称 Name	规格 Specification
JT-AS-YB	玻璃门移门矮柜 Glass sliding door cabinet	900W × 450D × 1050H
JT-AS-DB	玻璃门对开门矮柜 Glass door storage cabinet	900W × 450D × 1050H
JT-AS-D	对开门矮柜 Storage Cabinet	900W × 450D × 1050H
JT-AS-Y	移门矮柜 Sliding Door lower Cabinet	900W × 450D × 1050H
JT-JS-1050	卷门矮柜 Rolling Door lower Cabinet	900W × 450D × 1050H
JT-AWT-YB1050	玻璃门移门矮柜 Toughened glass sliding door cabinet	900W × 450D × 1050H
JT-AWT-YB900	玻璃门移门矮柜 Toughened glass sliding door cabinet	900W × 450D × 900H
JT-AWT-Y1050	移门矮柜 Sliding door cabinet	900W × 450D × 1050H
JT-AWT-Y700	移门矮柜 Sliding door cabinet	900W × 450D × 700H
JT-AWT-Y450	移门矮柜 Sliding door cabinet	900W × 450D × 450H

FILE CABINET— HIGHER CABINET
文件柜系列-高柜

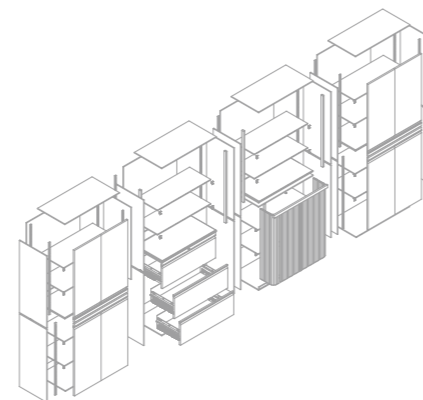

LISTEN TO THE
QUALITY

PRODUCT FEATURES

产品特点

- K.d.
- Combination of HM and TM series
- Elegant and strong hinges open at 180 degree
- Ball bearing slides with full extension
- Loading capacity: 60 kilos per drawer
- Interchangeable functions

- 全拆装结构
- HM 与 TM 系列文件柜的完美组合
- 配备高品质的加强门铰
- 配置滚珠轨道，柜桶全拉出
- 每个柜桶载重可达 60kgs
- 功能千变万化

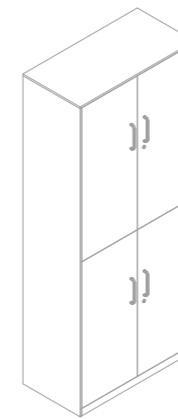

JT-GU-001

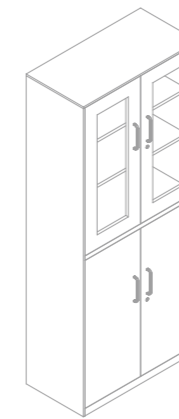

JT-GU-002



JT-GU-003

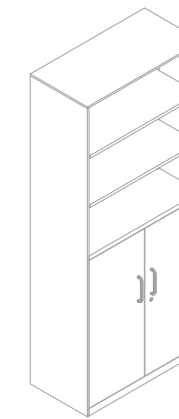

JT-GU-004



JT-GU-005

型号 Model	名称 Name	规格 Specification
JT-GU-001	双掩门高柜 Double door cabinet	900W × 450D × 2100H
JT-GU-002	玻璃门双掩门高柜 Double glass door cabinet	900W × 450D × 2100H
JT-GU-003	无门三抽高柜 Non door high three drawer	900W × 450D × 2100H
JT-GU-004	无门双掩门高柜 Non door high cabinet	900W × 450D × 2100H
JT-GU-005	双掩门高柜 Double door cabinet	900W × 450D × 2100H

FILE CABINET SERIES-CABINET SPACE

文件柜系列-空格柜



Model : JT-DA-001
Name : 掩门钢柜
Size : 900WX450DX480H



PRODUCT FEATURES

产品特点

- Molded by cold-rolled steel
- Non-door structure
- Strong, durable and external appearance elegant
- Against corrosion and scratch
- Shelves adjustable

- 柜体采用冷轧钢板模压成型
- 无门结构
- 坚固耐用外观大气
- 防腐蚀防磨损
- 可自由调节层板高度



JT-KG-2100

JT-KG-1800

JT-KG-1500

JT-KG-1200

JT-KG-900

型号 Model	名称 Name	规格 Specification
JT-KG-2100	空格柜 Open Door Cabinet	900W × 450D × 2100H
JT-KG-1800	空格柜 Open Door Cabinet	900W × 450D × 1800H
JT-KG-1500	空格柜 Open Door Cabinet	900W × 450D × 1500H
JT-KG-1200	空格柜 Open Door Cabinet	900W × 450D × 1200H
JT-KG-900	空格柜 Open Door Cabinet	900W × 450D × 900H

FILE CABINET SERIES- LATERAL DRAWING CABINET 文件柜系列-横抽柜



PRODUCT FEATURES

产品特点

- 选用冷轧钢板一次冲压成型；
- 喷淋前处理系统喷涂前所有部件全部经过处理，确保表面不含油污及锈蚀；
- 焊接采用数码电焊机及二氧化碳保护焊接，确保工件的焊接强度及焊接平整光滑；
- 静电喷塑粉系统以及电子控温燃油固化系统，确保工件受热均匀，塑粉附着力强环保无污染。
- 表面涂层坚固耐用，耐冲压，耐腐蚀，整洁美观，不易燃、防潮不变形。
- 上下左右搭配组合，可无限延伸。

- Excellent cold roll steel, stamping .
- Spraying per treatment , Surface degreasing, derusting, phosphating for each part to avoid contain oil and rust.
- Used the Digital welding and Carbon dioxide protection welding to make sure each parts to be strength and smooth.
- Electrostatic powder spray systems and electronic fuel temperature curing system, ensure that the workpiece is uniform heating, the powder coating adhesion strong enough and no environmental pollution.
- The study and durable coating surface ,impact resistance ,corrosion resistance 、 neat and beauty view, moisture proof
- Freely matching , Available extension

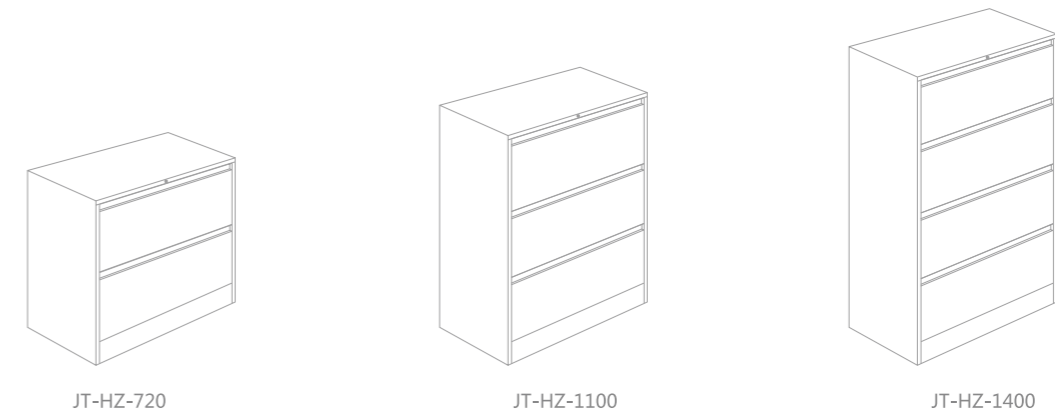

型号 Model	名称 Name	规格 Specification
JT-HZ-720	横向两抽文件柜 2-drawer Vertical Filing cabinet	900W × 450D × 720H
JT-HZ-1100	横向三抽文件柜 3-drawer Vertical Filing cabinet	900W × 450D × 1100H
JT-HZ-1400	横向四抽文件柜 4-drawer Vertical Filing cabinet	900W × 450D × 1400H

ULTIMATE ADAPTABILITY



PRODUCT FEATURES

产品特点

Ps型移动文件柜，流畅明快的线面结合展现简约的现代美感，配合不同色彩、尺寸和样式的随心定制，让办公搭配不受约束。

File Cabinet Series –Pedestal Cabinet
The pedestal file cabinet series, excellent design give the user endless freshness, and provide more options for the modern office. Size, color and design can be customized.

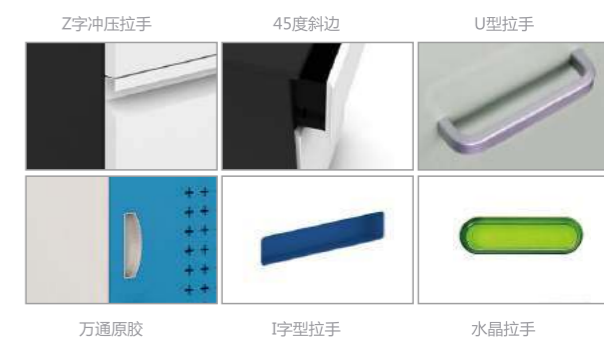

FILE CABINET SERIES –PEDESTAL CABINET
文件柜系列-活动柜



PRODUCT FEATURES

产品特点

- Multiple handle for selection
- Central lock design
- Tilting prevention device : The fifth wheel
- Sliding track and Ball bearing track for selection
- Suitable for the A3 & A4 size file
- Master key lock & password lock for selection

平面拉手面板，有多种拉手可供选择
中央锁设计
配备防倒装置：第五个脚轮
可配置自滑轨或滚珠轨道
可挂A3或A4文件夹
可选配普通锁，密码锁

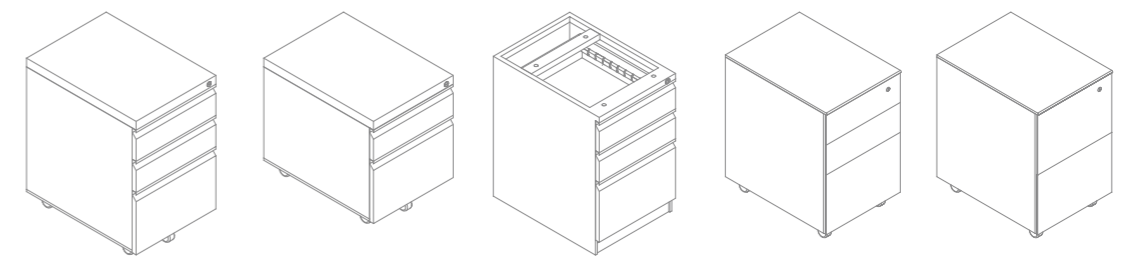

JT-HZ-630

JT-HZ-500

JT-TDZ-725

JT-HX-630

JT-HX-500

型号 Model	名称 Name	规格 Specification
JT-HZ-630	活动柜 Pedestal Cabinet	400W × 550D × 630H
JT-HZ-500	活动柜 Pedestal Cabinet	400W × 550D × 500H
JT-TDZ-725	台底柜 Base cabinet	400W × 550D × 725H
JT-HX-630	活动柜 Pedestal Cabinet	400W × 550D × 630H
JT-HX-500	活动柜 Pedestal Cabinet	400W × 550D × 500H

FILE CABINET SERIES –PEDESTAL CABINET

文件柜系列-活动柜

- Multiple handle for selection
- Central lock design
- Tilting prevention device : The fifth wheel
- Sliding track and Ball bearing track for selection
- Suitable for the A3 & A4 size file
- Master key lock & password lock for selection

平面拉手面板，有多种拉手可供选择
 中央锁设计
 配备防倒装置：第五个脚轮
 可配置自滑轨或滚珠轨道
 可挂A3或A4文件夹
 可选配普通锁，密码锁



Model : JT-HU-630
 Name : 活动柜
 Size : 400W × 550D × 630H

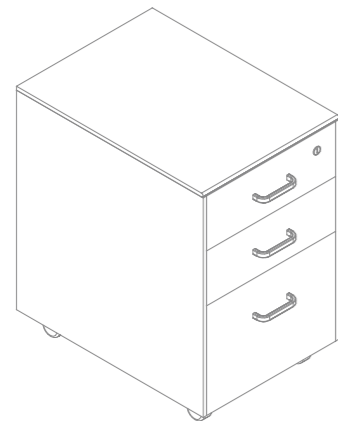

Model : JT-HU-500
 Name : 活动柜
 Size : 400W × 550D × 500H



PRODUCT FEATURES

产品特点

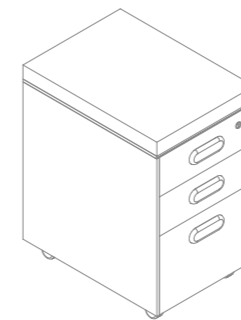

Model : JT-TDS-725
 Name : 台底柜
 Size : 400W × 550D × 725H

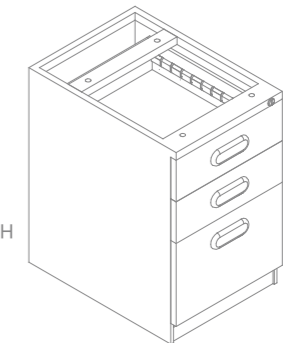

Model : JT-HS-630
 Name : 活动柜
 Size : 400W × 550D × 630H



Model : JT-HS-500
 Name : 活动柜
 Size : 400W × 550D × 500H



LOCKER/ WARDROBE
衣柜/储物柜系列

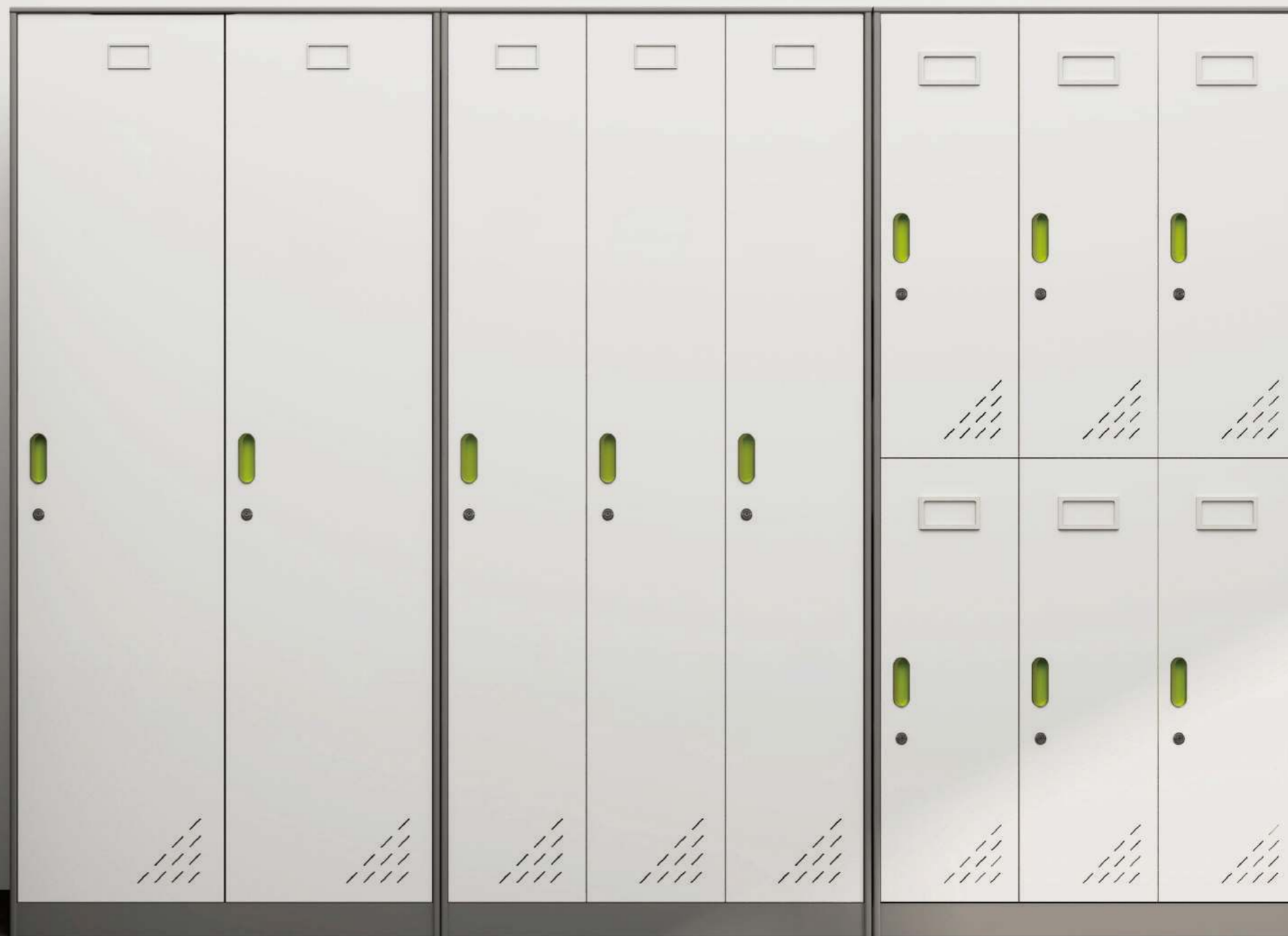

智能柜

文件柜

衣柜储物柜

图书柜

密集柜

公寓床/货架

LOCKER/ WARDROBE

衣柜/储物柜系列



PRODUCT FEATURES

产品特点

- High quality cold-rolled steel, more durable
- Phosphate surface treatment, acid and corrosion resistance
- With 6 combination number lock, more safe and convenience
- With linear design, more beautiful and high-class
- Interior shelves adjustable
- Professional and experienced Production Processes
- Handles and locks are optional
- With ventilation in the door
- Label handle and other accessories are optional
- Color is optional

- 选用优质冷轧钢板，更坚固耐用
- 表面磷化处理，耐酸碱，防腐蚀
- 6位机械锁，更安全
- 整体线条设计，尽显高端大气
- 内部层板可自由调节高度
- 多道工序流水精工制作
- 门锁，拉手可自由选配
- 门板配备透气孔
- 各种配件类：标签座、拉手等随心配备
- 颜色可选

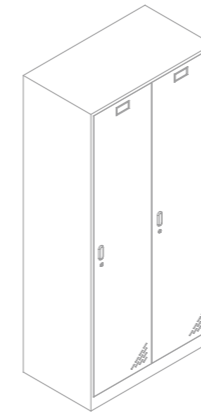

JT-YS-2

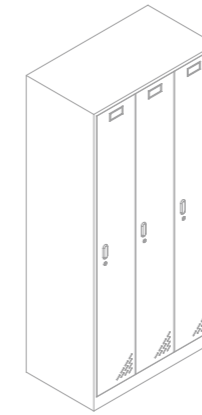

JT-YS-3

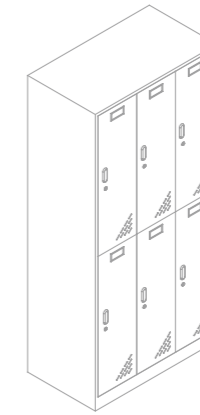

JT-YS-6

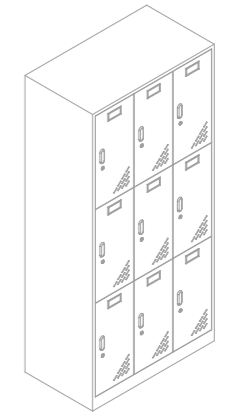

JT-YS-9

型号 Model	名称 Name	规格 Specification
JT-YS-2	水晶拉手2门衣柜 Crystal handle 2 door wardrobe	900W × 550D × 1900H
JT-YS-3	水晶拉手3门衣柜 Crystal handle 3 door wardrobe	900W × 550D × 1900H
JT-YS-6	水晶拉手6门衣柜 Crystal handle 6 door wardrobe	900W × 550D × 1900H
JT-YS-9	水晶拉手9门衣柜 Crystal handle 9 door wardrobe	900W × 550D × 1900H

LOCKER/ WARDROBE

衣柜/储物柜系列



PRODUCT FEATURES

产品特点

- High quality cold-rolled steel, more durable
- Phosphate surface treatment, acid and corrosion resistance
- With 6 combination number lock, more safe and convenience
- With linear design, more beautiful and high-class
- Interior shelves adjustable
- Professional and experienced Production Processes
- Handles and locks are optional
- With ventilation in the door
- label handle and other accessories are optional
- Color is optional

- 选用优质冷轧钢板，更坚固耐用
- 表面磷化处理，耐酸碱，防腐蚀
- 6位机械锁，更安全
- 整体线条设计，尽显高端大气
- 内部层板可自由调节高度
- 多道工序流水精工制作
- 门锁，拉手可自由选配
- 门板配备透气孔
- 各种配件类：标签座、拉手等随心配备
- 颜色可选

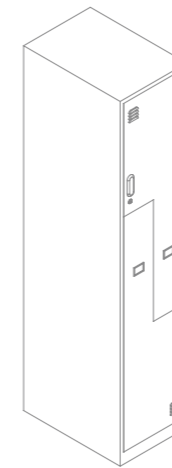

JT-YS-2



JT-YWT-3

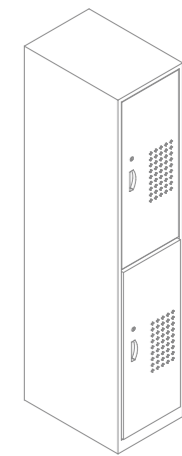

JT-YWT-2



型号 Model	名称 Name	规格 Specification
JT-YS-2	二门衣柜 Two door wardrobe	400W × 550D × 1800H
JT-YWT-3	三门衣柜 Three Door Wardrobe	400W × 550D × 1800H
JT-YWT-2	二门衣柜 Two door wardrobe	400W × 550D × 1800H

BOOKSHELF

书架



PRODUCT FEATURES

产品特点

防火板双立柱书架

底座钢结构，双立柱带可调节孔，层板高度可任意调节。全拆装，可配木侧护板、木顶板、木裙角。侧板冲孔减重并带有标牌镶嵌框，方便管理。层板中间设有档条，使两侧文件互不干涉，按库房管理高度可以选配书架层数。

Fire-proof double column bookshelf

Steel Base, double column with adjustable holes, inner shelves can be adjustable, fully Knocked-down design. It can be decorated with MDF panel on front, top and bottom. The front panel with label, management more easy. There is a stopping strip between two layer shelves to avoid mixing files between two shelves. The size of bookshelves can be customized according to the room size.

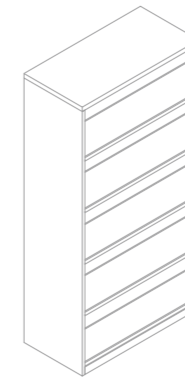

Model : JT-ZZ-2100
Name : 单面杂志架
Size : 900W × 450D × 2100H

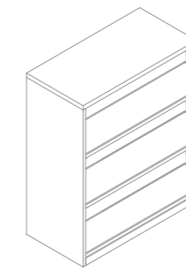

Model : JT-ZZ-1050
Name : 单面杂志架
Size : 900W × 450D × 1050H

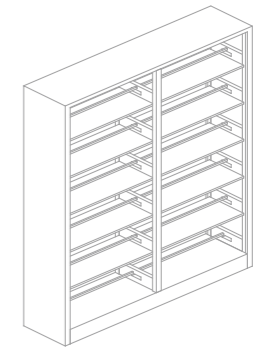

Model : JT-TS-2000
Name : 双面书架
Size : 1900W × 450D × 2000H

钢制双立双面存放书架

底座钢结构，双立柱带可调节孔，层板高度可任意调节。全拆装，侧板冲孔减重并带有标牌镶嵌框，方便管理。层板中间设有档条，使两侧文件互不干涉，按库房管理高度可以选配书架层数。

Steel double column double side bookshelf

Steel Base, double column with adjustable holes, inner shelves can be adjustable, fully Knocked-down design. It can be decorated with MDF panel on front, top and bottom. The front panel with label, management more easy. There is a stopping strip between two layer shelves to avoid mixing files between two shelves. The size of bookshelves can be customized according to the room size.



INTELLIGENT SYSTEM MOBILE SHELVES 智能密集架



智能密集架在档案管理的计算机界面上可开启或关闭密集架电源，不用工作人员来回奔忙，而管理计算机可设置于客户需要的任何地方；通过密码权限对档案密集架进行操作。

密集架分类/Shelves classification

根据内部结构：立柱式、半封闭式、全封闭式、悬挂式、油画式、底图柜式。

根据驱动方式：手动密集架、电动密集架、智能密集架。

根据颜色：套色、木纹转印

The power can be open or closed by oprating to the interface of the computer. The computer can be placed anywhere needed. The operation can be realised by get penmission of the password.

Internal structure classification:column type,semi-close type, full-closed type ,hanging type,oil painting type,drawing type.

Driving mode:manual shelves,electric shelves,intelligent shelf.

Color:topping wooden transfer.

SPACE LIBERATION

空间解放者



TYPE COMPACT SHELF SYSTEM

手动密集架

使用优质冷轧钢板设计，更坚固耐用
柜体之间设有防撞装置
卓越的承重能力加大了存储量，更节约空间
结构精加工处理，层板之间可以自由调节
人性化设置：顶部防尘板+底部防鼠板+架体防倾倒设计
可按实际需求进行设计定制，十年保修

- Using high quality cold-rolled steel plate for design, more durable
- Between each row with anticollision device
- Excellent loading capacity to increase the storage quantity to saving more space .
- Sepcial structure design ,shelves can be adjustable freely
- Humanized setting : dustproof top plate+ ratproof dvice at bottem + anti-tilting device for
- Can be customized according to the actual demand, ten years warranty

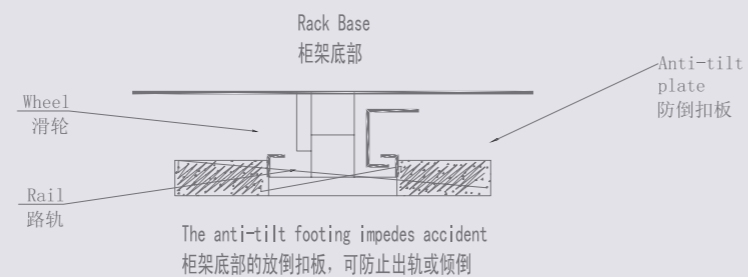

PRODUCT FEATURES

产品特点

规格 Specification						技术参数 Technical Parameter				
结构型式 Structure	深度 Depth	架长 Length	架高 Height	层数 NO. of Layer	层高 Height of Layer	节数 NO. of tier	架长 Length	轨道数 NO. of rail	搁板承重 Weight capacity	附注说明 Illustration
双面活动架 (中列) Double side storage middle row	520	900	2150	5	375	2	85	2	资料架 ≥ 60kg Shelf of Data ≥ 60kg	1. 摇把 (控制钮) 距地面高度为 1000。 2. 库房地面承受要求 ≥ 700kg/m. 达不到要求的可采用工字钢或槽钢进行加固。 3. 特殊情况可按客户要求
	550			6	325	3	85	2		
	600			7	275	4	85	3		
	660			8	250	5	85	3		
	700			12	150	6	85	4		
单面边架 (侧架) Single side storage side row	350					7	85	4	货架 ≥ 80kg Shelf of cargo ≥ 80kg	1. The distance from crank (break botton) to floor is 1000. 2. The weight capality requirement ≥ 700kg/m ² 3. Any special specification, can be designed according to your requirement.
	410					8	85	5		
	450					9	85	5		
						10	85	6		

机械式移动密集文件架 (柜) Mechanical Compact Shelf						
NUMBER OF BAYS	WIDTH	SINGLE FIXED	SINGLE MOVABLE	DOUBLE MOVABLE 双面移动架		
				500D	600D	760D
1	1085	SF410-1	SM410-1	DM520-1	DM660-1	DM760-1
2	1985	SF410-2	SM410-2	DM520-2	DM660-2	DM760-2
3	2885	SF410-3	SM410-3	DM520-3	DM660-3	DM760-3
4	3785	SF410-4	SM410-4	DM520-4	DM660-4	DM760-4
5	4686	SF410-5	SM410-5	DM520-5	DM660-5	DM760-5
6	5585	SF410-6	SM410-6	DM520-6	DM660-6	DM760-6

HEIGHT 高度 2150mm WIDTH 宽度 (900xN)+185mm N 联数 : NO. of Bays

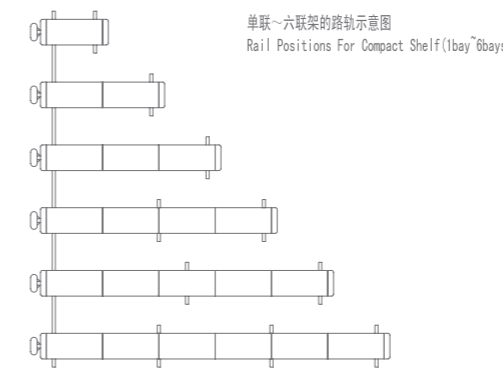
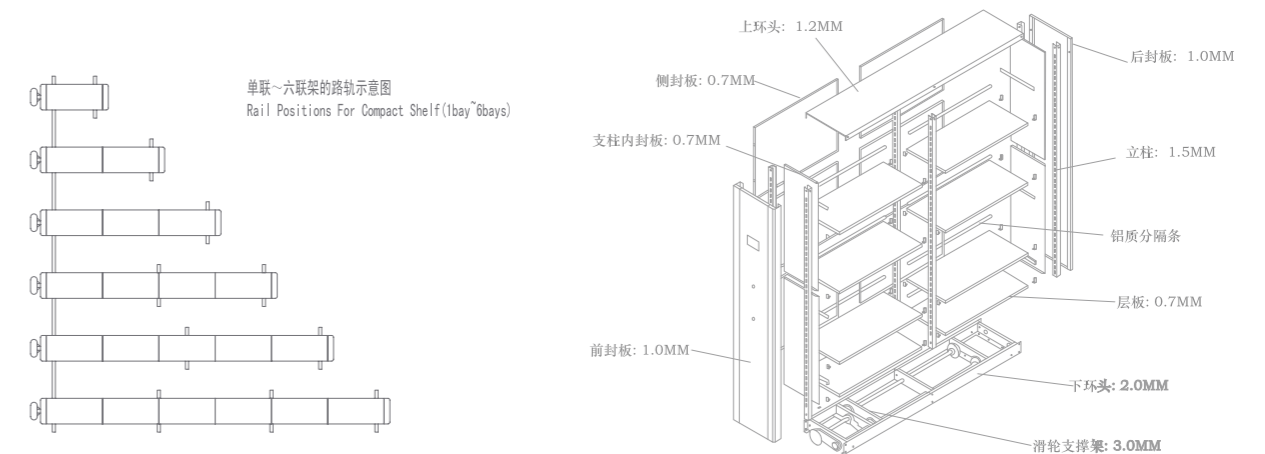
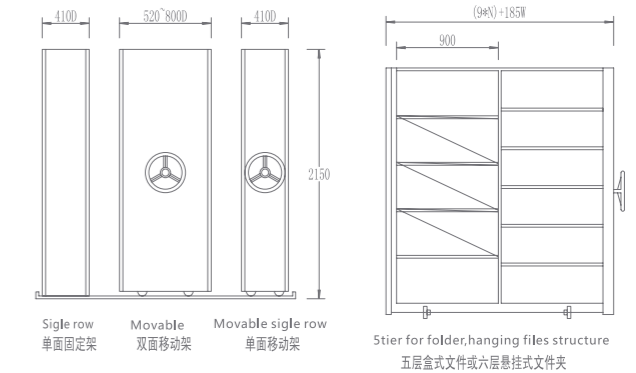

TYPE HAND-PUSH COMPACT SYSTEM

移动推柜



PRODUCT FEATURES

产品特点

手推货架式推柜

高度:2160
 材质:冷轧钢板
 颜色:基础白(BW)
 冷灰(CG)
 墨灰(DG)
 锁具:一个锁
 层板:4片(一联单面)/8片(一联双面)
 8片(二联单面)/16片(二联双面)

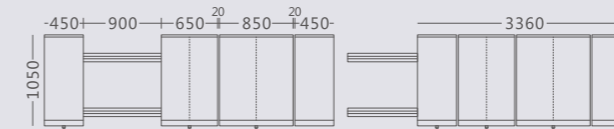
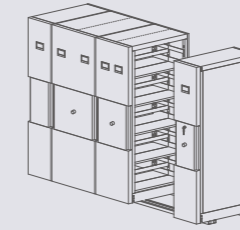

手推货柜式推柜

高度:2160
 材质:冷轧钢板
 颜色:基础白(BW)
 冷灰(CG)
 墨灰(DG)
 锁具:一个锁
 层板:4片(一联单面)/8片(一联双面)
 8片(二联单面)/16片(二联双面)

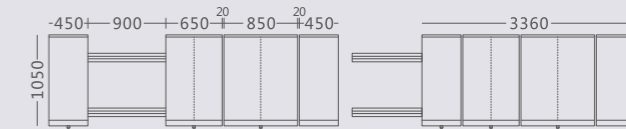
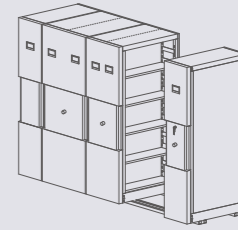

手推货架式推柜

高度:2160
 材质:冷轧钢板
 颜色:基础白(BW)
 冷灰(CG)
 墨灰(DG)
 锁具:一个锁
 层板:4片(一联单面)/8片(一联双面)
 8片(二联单面)/16片(二联双面)

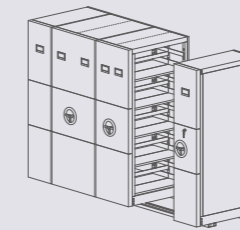

手推货柜式推柜

高度:2160
 材质:冷轧钢板
 颜色:基础白(BW)
 冷灰(CG)
 墨灰(DG)
 锁具:一个锁
 层板:4片(一联单面)/8片(一联双面)
 8片(二联单面)/16片(二联双面)

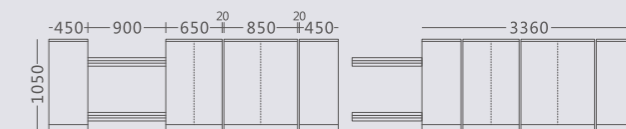
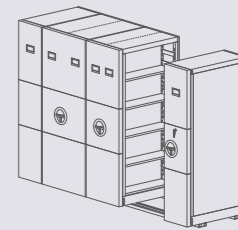

ROLL
 WITH IT

MOBILE STORAGE RACK 移动货架

密集货架

同样的房间使用面积情况下，密集货架的储存量比普通货架储存量的两倍以上；

架体之间设计有缓冲密封条。密封条采用永磁抗老化的塑胶，结合紧密，不变形，不脱落，架体合拢后两侧良好密封，合拢时起缓冲作用；

每列设有锁紧装置，当工作人员进入架体工作时，将锁紧装置扭到锁紧位置，此时其他人员无法摇动架体，以保证架内人员的安全。每组密集货架边列装有锁具，其闭合后，用锁锁住后，形成一个封闭的整体；

每列设有防倒装置，在底盘的下方固定有防倒钩，在正常运行时防倒钩与轨道灯间隙滑动，当货架收到倾斜力时，通过底盘上的防倒钩将力传到轨道上，并通过联接轨道与地面的膨胀螺栓钉传到地面，以保证架体不倾斜。

Mobile shelf

In the case of same area ,the mobile shelf storage capacity is twice as the ordinary storage shelf.

The sealing strip is installed between the shelves. The sealing strip is made of permanent magent plastic ,are designed to absorb some of the impact.

Each line is provided with a locking device.when the staff enter,lock the brake to keep the safety of the staff.Each group of the shelf has a side lock.when it is closed and lock become a closed model.

Each line is equipped with an anti tilting devices on the base,to prevent dumping.

PRODUCT FEATURES

产品特点



APARTMENT BED 公寓床



Model: JT-C-002
Name: 单人多功能床
Single-person Multi-functional bed
Size: 2000W × 900D × 1750H

PRODUCT FEATURES

产品特点

新型公寓床系列

公寓床是由床、书柜、衣柜、书桌和梯架等组成的一款为学校学生宿舍、工厂员工宿舍、建筑住宿等专门设计使用的床，并可随意组合。住宿学生的上下床有效的节省空间，同时解决校舍不足问题。

New Style Apartment Bunk Bed Series

Apartment bed is specially designed for school dormitories, staff dormitories, building accommodations. It consists of bed, bookcase, wardrobe, desk and ladder. All of these parts can be combined freely. The newly bed can be space saving and solves the problem of inadequate dormitories.



Model: JT-C-001
Name: 单人多功能床
Single-person Multi-functional bed
Size: 2000W × 900D × 1750H



make a product as a Smart Manufacturer?

一件产品是如何智造的？

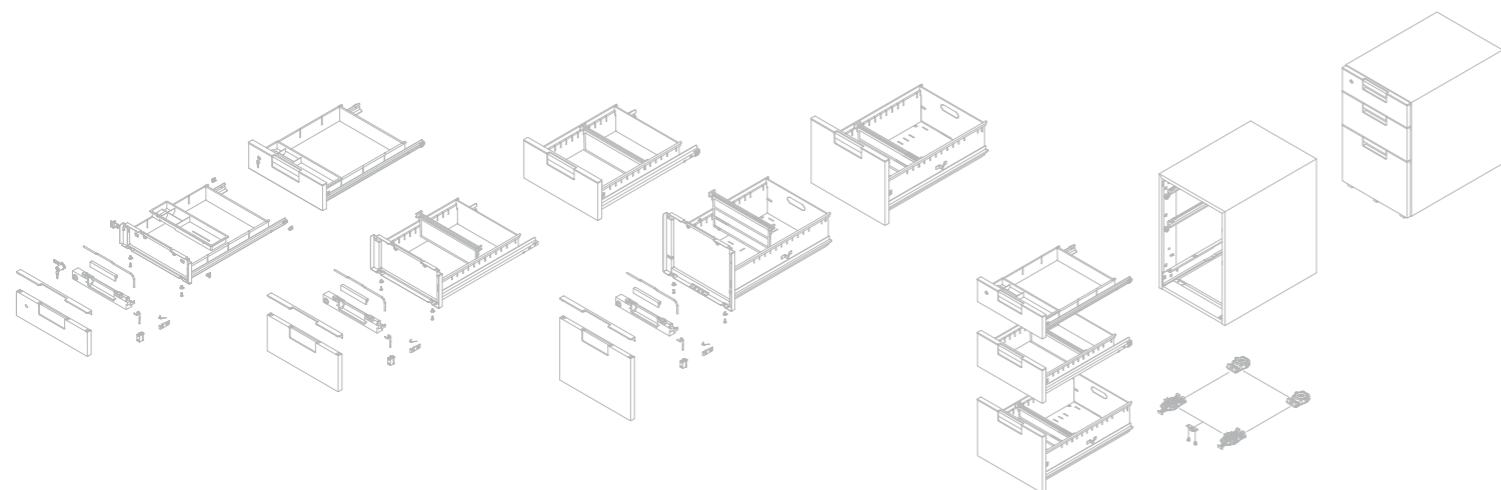

Each database consists of 3 main elements, body part, drawer and castors (glides), made of 108 individual standard spare parts. Standardization of each part enables convenient replacement, management, maintenance and recycles.

抽屉柜由柜壳、抽屉、滑轮（脚杯）三大部分，共108个标准零部件构成。严格、规范的标准使每个零部件都可以实现互换，方便管理、使用、维护与回收作业。



Made of **108** individual standard spare parts
抽屉柜由108个标准零部件构成

Durability
坚固的柜壳



The Case of Database is made of 0.8mm thickness steel sheet. Steel bars are welded inside the body part to enhance structural strength of the Database significantly.

0.8mm钢板外壳，强力支撑钢筋焊接内框，坚固不变形。

QUALITY & PATENT ADVANTAGES

质量与专利优势

材料和工艺

如果说设计决定了产品的先天品质，那么对材料与工艺的选择则决定了产品的先天质量与成本。为了生产高质量和具有价格优势的产品，键特凭借对产品和产品经营定位的深刻理解，不断对产品提出更高的要求，根据产品的外观造型、功能需要、环保要求选择准确的材料，制定恰到好处的加工工艺，确保生产的产品不仅坚固耐用，质量上乘，同时价格适宜。在质量与价格成正比的循环中努力寻找最完美的契合点。

高水准生产

在键特的现代化工厂里，我们引进先进数码生产线，完善生产制造硬件设施。键特自己设计制造的模具、工具和特殊设备，确保产品的高质量及时交付。同时键特更注重创建智慧的工厂。通过企业资源管理软件，进行数字化操作，严控成本和严把质量关，对交付每个客户的每一件产品都要求按时按质、力臻完美。

从原料到最终产品的每个环节的质量都得到了严格控制。我们深深的懂得，每一个细节都能决定成败，对细节的要求我们几近苛刻。只有这样，才能让我们的产品彻底赢得客户的信赖与支持。

十年保用，便利客户

键特工厂通过了ISO 9001:2000质量管理体系认证。实际中，我们的产品质量标准来源于美国和世界的质量标准。在产品之初，我们就选择持久耐用，性价比高的材料，制定最恰到好处的加工工艺。在样品阶段，每个零部件将经过各方面的测试和考验，才能被获准正式生产。这不仅包括常规的产品，对根据客户特殊需要定制的产品，我们对质量的要求也毫不松懈。

产品十年保用，真正便利客户，是键特人对产品质量孜孜不倦追求的最好承诺。



本公司拥有严谨的生产流程和标准的品质要求，更得到ISO9001国际管理体系标准和ISO4001环境管理体系标准认证。并且在外观和功能实用设计上拥有多个专利。

Strict production process & high-quality standard
ISO9001:2008 and ISO14001:2004 passed
Patents on product appearance & functions



Production and packing:

If we say that the innate quality is determined by design, the choice of material and technology which determine the innate quality and cost of products. In order to produce high quality and has a price advantage of the products, Jeanter have deep understanding of product and product management localization, put forward higher requirements of the product continuously, according to the requirements of the product appearance modeling, function, environmental protection requirements, it choose accurate materials, make proper machining process, to ensure the production of products not only strong and durable, good quality, affordable at the same time. In quality and price is proportional to the cycle of trying to find the perfect spot.

High standards of production:

In our Jeanter modern factory, it was bring in the progressive and digital production lines, improve manufacturing hardware equipment. In order to ensure production high quality and on time delivery of products, Jeanter designed their own special molds, tools and special equipment. At the same time Jeanter pays high attention to create a special intelligence manufacturer, We are under the digitized operation to control cost, strict quality control through enterprise resource management software; seriously to treat each product is meet client's requirement. From raw materials to final production, we strictly controlled for each step. We deeply understand that every detail can decide the success or failure, Focus on the quality is the only way to win the trust and support

10 Years Warranty, Customer Convenience

And in product quality management system, Guangzhou Jeanter already through the ISO9001: 2000 international quality management system certification. Our product quality standard is based on the World's Highest Quality-Standardized. In designing stage, we insist to use the durable and cost-effective materials, also work out the most proper processing technology. In sample stage, each parts of accessories need to be inspected and tested, and then can used in the production. We not only do that in our conventional products, but also in the customized product. We will continue to be relentless in the quality of our product. 10 Years Warranty, Customer Convenience, Good quality is our tireless pursuit and promise.



对可持续生命周期的考虑：键特产品的设计、使用、处理，无论从材料、生产、运输、使用直到生命周期结束对其产品的每个构成零部件，都进行了仔细的考虑，以减少对环境的影响。每个产品零部件的设计，从最初开始就融入了对环保的考虑，而不是一个后发的思考。

材料：简洁的结构及设计，有助减少原材料的应用及生产过程中的废料。我们认真研究材料的化学成分，选择安全健康的材料。为减少材料虚耗以及减轻对环境的影响，积极使用含有高比例可回收成分的材料(比如铝压铸及钢制部件)以及容易回收的材料(比如挤压铝、聚酯纺织品)。

生产与包装：产品设计将生产过程中的浪费、能源消耗以及对环境影响减至最低。所有钢制部件外表均由粉末覆盖，选用了阿克苏诺贝尔的绿色涂料产品。阿克苏诺贝尔是全球最大的油漆和涂料公司，拥有世界领先的技术。另外，键特的喷涂过程不含铅和有毒溶剂，没有任何有害的VOC(挥发性有机化学物)，所有用过的粉体都得到重新利用或进行再回收。轻型可拆卸包装可使材料的使用降到最低程度，并减少运输与分销过程中的能源消耗。

生命周期结束：设计周全的弃置策略，采取对环境负责的处理方法，包括再销售、翻新、回收或捐赠。为了实3Rs(减少、再利用、再循环)，每个部件都易于拆卸，以便循环利用。

Considering the sustainable life cycle:

The design, use, processing from Jeanter, in order to reduce the impact on the environment, no matter from the material, the production, transportation, use until the end of the life cycle for each constitute part of products which all have a careful consideration. Each design of product's component, from the beginning is blended in consideration to the environmental protection, rather than the last to think.

Row material:

Simply structure and designs is good for save row material cost and to avoid more scrap material. We have carefully studied the chemical composition of the material to choose a safe and healthy type. We consider to improve utilization rate of material and environmental protection, we prefer to use the material which high proportion of recyclable components and easily recyclable, such as the Steel and aluminum die-casting parts.

Production and packing:

We already consider to reducing the production waste, energy consumption and environmental pollution during the production when we work on the designing. All steel components surface are covered with the environment-friendly powder coating from Akzo Nobel Chemicals Company. Akzo Nobel Chemicals Company is the world's largest paints and coatings company, has the world's leading technology. In addition, the spraying process from GZ Jeanter is without lead, poisonous solvents or VOC (volatile organic chemicals), all the coatings can be reused and recycled. Lightweight removable packaging can make the use of material to a minimum level, and to reduce the energy consumption in the process of transportation and distribution.

Usage period:

Researching the recycling strategies to make support environmental protection, including resale, refurbishment, Recycling or donation, In order to achieve 3Rs (reduce, reuse and recycle), each components is easily to disassemble for recycling.